

# märklin

---

H0

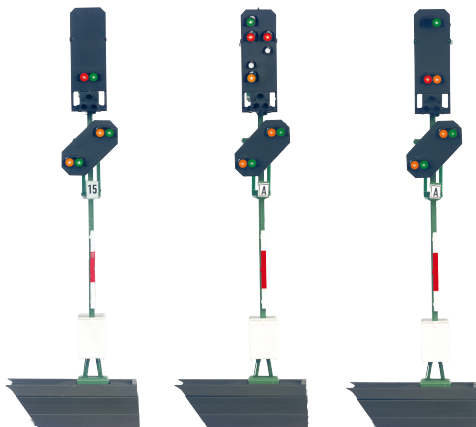

D GB USA F NL

Lichtsignal mit Vorsignal  
**76495/76496/76497**



<b>Inhaltsverzeichnis</b>	Seite
Signalbilder beim Vorbild	4
Bestimmungsgemäße Verwendung	6
Lieferumfang	6
Sicherheitshinweise	6
Wichtige Hinweise	6
Technische Daten	6
Funktionen	6
Signal-Einbau	7
Programmierung mit CS 2	7
Entsorgung	9
Garantie	9
Betriebsart und Adressen einstellen	22
Aufbau	33
Aufkleber anbringen	43











<b>Table of Contents</b>	Page
Signal Aspects in the Prototyp	4
Intended Use of the Product	10
Contents as Delivered	10
Safety Notes	10
Important Notes	10
Technical Data	10
Functions	10
Signal Installation	11
Programming with the CS 2	11
Disposing	13
Warranty	13
Setting the mode of operation and addresses	18
Setup	33
Attach decals	43

<b>Sommaire</b>	Page
Positions signalétiques réelles	4
Utilisation conforme	14
Livraison	14
Consignes de sécurité	14
Consignes importantes	14
Caractéristiques techniques	14
Fonctions	14
Montage du signal	15
Programmation avec CS 2	15
Elimination	17
Garantie	17
Définir le mode d'exploitation et les adresses	22
Montage	33
Fixez les autocollants	43

<b>Inhoudsopgave</b>	Pagina
Seinbeelden bij het voorbeeld	4
Beoogd gebruik	18
Leveringsomvang	18
Veiligheidsvoorschriften	18
Belangrijke aanwijzingen	18
Technische gegevens	18
Functies	18
Sein inbouwen	19
Programmeren met CS2	19
Afdanken	21
Garantie	21
Bedrijfsmodus en adres instellen	22
Opbouwen	33
Stickers bevestigen	43

**Signalbilder beim Vorbild**  
**Signal Aspects in the Prototyp**

**Positions signalétiques réelles**  
**Seinbeelden bij het voorbeeld**

<p>Signalbild Hauptsignal:          Signal aspect for a home signal:          Position de signal principal:          Seinbeeld hoofdsein:</p>	 76495	 76497	 76496	 76497	 76496	 76495	 76497
<p>Bedeutung:          Meaning:          Signification:          Betekend:</p>	<p>Fahrt          Go          Voie libre          Rijden</p>		<p>Langsamfahrt          Proceed Slowly          Ralentissement          Langzaam rijden</p>		<p>Halt          Stop          Arrêt          Stop</p>		
<p>Signalbild Vorsignal des folgenden Hauptsignals:          Signal aspect of the home signal that follows it:          Indication signal du prochain signal d'arrêt:          Seinbeeld van het volgende hoofdsein:</p>	<p>3 Möglichkeiten - 3 possibilités          3 possibilités - 3 mogelijkheden</p>						
							
<p>Bedeutung:          Meaning:          Signification:          Betekend:</p>	<p>Halt erwarten          Prepare to stop          Prévoir arrêt          Verwacht Stop tonend</p>	<p>Fahrt erwarten          Prepare to proceed          Prévoir voie libre          Verwacht veilig</p>	<p>Langsamfahrt erwarten          Prepare to proceed slowly          Prévoir ralentissement          Verwacht langzaam rijden</p>	<p>aus          off          débranché          uit</p>			

**Fahrstrom:**

**Track Current:**

**Courant traction :**

**Rijstroom:**

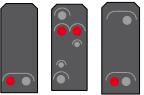
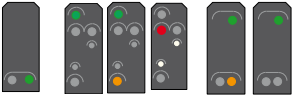
 <p>76495 76496 76497</p>	 <p>76495 76496 76497</p>
<p>aus off débranché uit</p>	<p>ein on branché aan</p>

## Bestimmungsgemäße Verwendung

- Das Signal ist zum Einbau in H0 Digital-Modellbahn-Anlagen.
- Das Signal darf für den Analogbetrieb nur mit Stellpult 72760 verwendet werden.
- Darf nur in geschlossenen Räumen verwendet werden.

## Lieferumfang

- 1 Signal
- 1 Decoder mit Halteplatte
- 1 Kabel mit Stecker 2 polig, rot und braun
- 1 Kabel mit Stecker 3 polig, - rot und rot
- 1 Kabel mit Stecker 2 polig weiß und violett
- 1 Kabel mit Stecker 3 polig, violett, rot-grün, rot-braun
- 1 Fundament K-Gleis mit Abdeckung
- 1 Steigungskeil
- 1 Abdeckung für Unterflurmontage
- 1 Schraube 2 x 10mm
- 2 Schrauben 2,5 x 20mm
- 4 Isolierungen (rot) C-Gleis (1Spritzling)
- 2 Mittelleiter-Isolierung (grau) K-Gleis
- 1 Mittelleiter-Anschluss K-Gleis
- 1 Schiebebilder zur Kennzeichnung
- Einbauanleitung
- Garantieurkunde

## Sicherheitshinweise

- **ACHTUNG!** Funktionsbedingte scharfe Kanten und Spitzen.
- Verkabelungs- und Montagearbeiten nur im spannungslosen Zustand ausführen. Bei Nichtbeachtung kann es zu gefährlichen Körperströmen und damit zu Verletzungen führen.
- **Signal nur mit der zulässigen Spannung** (siehe technische Daten) **betreiben**.

## Wichtige Hinweise

- Die Bedienungsanleitung ist Bestandteil des Produktes und muss deshalb aufbewahrt sowie bei Weitergabe des Produktes mitgegeben werden.
- Die Signalmasten der Signale 76395/76397 können mit dieser Elektronik (Decoder) nicht verwendet werden
- Für Reparaturen wenden Sie sich bitte an Ihren Märklin-Fachhändler.
- Entsorgung: [www.maerklin.com/en/imprint.html](http://www.maerklin.com/en/imprint.html)

## Technische Daten

- Versorgungsspannung 16 - 20 V
- Belastung  $\leq 100$  mA
- Belastung Gleis Ausgang max. 2 A
- Spannungsfestigkeit max. 40 V

## Funktionen

- Multiprotokoll fähig: fx (MM), mfx\* und DCC
- Einstellen der Betriebsart mittels DIP-Schalter
- Einstellbare Adressen mit DIP-Schalter:
  - 1-256** fx (MM) (Control Unit 6021)
  - 1-320** fx (MM) (Central Station 6021x/Mobile Station 60653)
  - 1-511** (DCC)
- Programmierbare Adressen über CV
  - 1-2.040** DCC
- Änderungen der Eigenschaften über CV
- Stromversorgung über Digitalstromkreis

\* mfx erst ab CS2 Softwareversion 4.0 (2.Quartal 2015)

## Signal-Einbau

Vor dem eigentlichen Einbau muss das Signal programmiert werden.

### **Folgende Arbeitsschritte dürfen nur im spannungslosen Zustand ausgeführt werden:**

Einstellung der Adresse und Betriebsart durch den DIP-Schalter:

- Einstellen der Betriebsart mit DIP-Schalter 10  
Schalter 10 off = fx (MM) / mfx  
Schalter 10 on = DCC
- fx (MM)/DCC einstellen der Adresse mit DIP-Schalter (Tabelle ab Seite 22)

### **! Beachten Sie:**

- Einstellungen mit dem DIP-Schalter immer spannungslos vornehmen. Das Signal erkennt erst mit dem Einschalten der Spannung die aktuellen Schalterstellungen.
- **Zum Schalten der Signale 76496 und 76497** werden grundsätzlich 2 Adressen (Tastenpaare) benötigt. Die 2. Adresse wird automatisch als Folgeadresse vergeben. Diese Folgeadresse **ist nicht frei wählbar**.

## Programmierung mit CS 2

### **fx (MM)**

Die CV Programmierung muss am Programmiergleis erfolgen. Es darf **immer nur ein Signal** am Programmiergleis angeschlossen werden.

Folgende CV's können bei fx (MM) verändert werden:  
CV 40,45,46,48, 50, 52 und 54.

Die Adresse für das am Mast befindliche Vorsignal wird bei 76495 die nächste -, bei 76496 und 76497 die übernächste **Adres-**

**se automatisch vergeben**. Diese Adresse kann nicht verändert werden.

Während des Programmiervorganges blinkt die Signallampe, abweichend davon wird während des programmierens mit der Central Station das Signal geschaltet. Nach Abschluss des Programmiervorganges wird das Signal auf „Fahrt“ gestellt.

Vor dem Programmieren mit der Mobile Station 2 muss eine fx Dummy-Lok mit der Adresse des Signales angelegt sein. Das Signal einmal betätigen, danach die gewünschten CV Einstellungen wechseln, ändern und zum Abschluß das Signal nochmals schalten.

Die Vorgehensweise beim Programmieren mit der Control Unit 6021 finden Sie auf [www.maerklin.de](http://www.maerklin.de) -> Tools & Downloads -> Technische Informationen.

Die Programmierung mit anderen Geräten, entnehmen Sie bitte der Bedienungsanleitung des jeweiligen Steuergerätes.

### **DCC**

Die CV Programmierung muss am Programmiergleis erfolgen. Es darf **immer nur ein Signal** am Programmiergleis angeschlossen werden.

Während der Datenübertragung blinkt zur Kontrolle das Signal.

Die Programmierung mit anderen Geräten, entnehmen Sie bitte der Bedienungsanleitung des jeweiligen Steuergerätes.

### **CV für fx (MM) und DCC**

Unter fx (MM) kann die Adresse nur mit dem DIP-Schalter eingestellt werden. Werte in Klammern sind die Werkseinstellungen.

CV	Bedeutung	Werte	
1	Adresse 1 - 255	1-255 (1)	nur DCC
9	Adressen 256 - 2040	0-7 (0)	nur DCC
33	Anzahl Ausgangs- adressen	—	nur DCC lesen
PoM* 40	Beleuchtung	0 - 15 (15)	0 licht aus dimmen 0-15, wobei 15 = 100% Helligkeit entspricht
PoM* 45	Signaltyp Hauptsignal: 76495 76497 76496	2 3 4	Blocksignal Einfahrtsignal Ausfahrtsignal
46	Signaltyp Vorsignal	2 3 4	gehört zu Blocksignal Einfahrtsignal Ausfahrtsignal
PoM* 48	Hauptsignal Umschaltzeit LED an/aus	0 - 3	0 = 0s 1 = 0,175s 2 = 0,35s 3 = 0,5s
PoM* 50	Überblendverhalten Hauptsignal	0 - 3	0 = gleichzeitig 1 = nacheinander 2 = nacheinander 0,1s Pause 3 = nacheinander 0,5s Pause

CV	Bedeutung	Werte	
PoM* 52	Vorsignal Umschaltzeit LED an/aus	0 - 3	0 = 0s 1 = 0,175s 2 = 0,35s 3 = 0,5s
PoM* 54	Überblendverhalten Vorsignal	0 - 3	0 = gleichzeitig 1 = nacheinander 2 = nacheinander 0,1s Pause 3 = nacheinander 0,5s Pause
55	Vorsignaladresse kurz (wie CV1) nur DCC		Wert des dazugehörigen Hauptsignals eintragen (nur DCC)
56	Vorsignaladresse lang (wie CV9) nur DCC		Wert des dazugehörigen Hauptsignals eintragen (nur DCC)

\*PoM programmieren kann, sofern es vom Steuergerät unterstützt wird, am Hauptgleis erfolgen.

#### **Einstellen und errechnen der Adressen größer 255 (DCC):**

Z.B. Adresse 1044 -> 1044:256=4,078125 . Der Wert vor dem Komma (4) ist in CV 9 einzutragen. Der Wert nach dem Komma (0,078125) wird mit 256 multipliziert  $0,078125 \times 256 = 20$ . Der errechnete Wert 20 muss in CV 1 eingetragen werden.



### Beispiel für die richtige Adressierung MM:

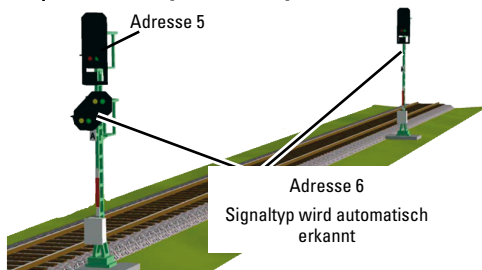

### Beispiel für die richtige Adressierung DCC:

Die Adresse des Vorsignales (CV55 / CV56) und der Signaltyp (CV46) muss der Adresse und dem Signaltyp des darauffolgenden Hauptsignales entsprechen. Nur so ist die richtige Wiedergabe des Signalbildes gewährleistet.

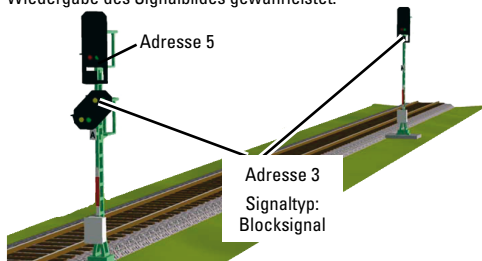

### Entsorgung



Hinweise zum Umweltschutz: Produkte, die mit dem durchgestrichenen Müllimer gekennzeichnet sind, dürfen am Ende ihrer Lebensdauer nicht über den normalen Haushaltsmüll entsorgt werden, sondern müssen an einem Sammelpunkt für das Recycling von elektrischen und elektronischen Geräten abgegeben werden. Das Symbol auf dem

Produkt, der Bedienungsanleitung oder der Verpackung weist darauf hin. Die Werkstoffe sind gemäß ihrer Kennzeichnung wiederverwertbar. Mit der Wiederverwendung, der stofflichen Verwertung oder anderen Formen der Verwertung von Altgeräten leisten Sie einen wichtigen Beitrag zum Schutze unserer Umwelt. Bitte erfragen Sie bei Ihrer Gemeindeverwaltung die zuständige Entsorgungsstelle.

### Garantie

Gewährleistung und Garantie gemäß der beiliegenden Garantieurkunde.

- Für Reparaturen wenden Sie sich bitte an Ihren Märklin-Fachhändler oder an  
Gebr. Märklin & Cie. GmbH  
Reparaturservice  
Stuttgarter Str. 55 - 57  
73033 Göppingen  
Germany  
☎: 07161 608 222 (nur aus dem Inland)  
E-Mail: Service@maerklin.de

## Intended Use of the Product

- This signal is for installation on H0 digital model railroad layouts.
- This signal may only be used for analog operation with the 72760 control box.
- Use only in enclosed areas.

## Contents as Delivered

- 1 Signal
- 1 Decoder with mounting plate
- 1 Cable with plug, 2-conductor, red and brown
- 1 Cable with plug, 3-conductor, red and red
- 1 white and violet wires with 2-pin plugs for plugs
- 1 Cable with plug, 3-conductor, violet, red-green, red-braun
- 1 K Track base with a cover
- 1 grade wedge
- 1 cover for below-baseboard installation
- 1 screw 2 x 10 mm
- 2 screws 2.5 x 20mm
- 4 Insulator sleeves (red) for C track (1 sprue)
- 2 Center conductor insulators (gray) for K Track
- 1 Center conductor connector for K Track
- 1 Set of decals for identification
- Installation instructions
- Warranty card

## Safety Notes

- **IMPORTANT!** The product has sharp edges and points due to the way it works.
- Do wiring and installation work only when there is no voltage present. Failure to adhere to this may cause life-threatening current and injury.
- **This signal is to be operated only with the permissible voltage** (see technical data).

## Important Notes

- The operating instructions are a component part of the product and must therefore be kept in a safe place as well as for transfer of the product to third parties.
- The signal masts for the 76395/76397 signals cannot be used with this electronic circuit (decoder).
- Please see your authorized Märklin specialty dealer for repairs.
- Disposing of the product: [www.maerklin.com/en/imprint.html](http://www.maerklin.com/en/imprint.html)

## Technical Data

- |                            |                 |
|----------------------------|-----------------|
| • Voltage supply           | 16 - 20V        |
| • Load                     | ≤ 100 milliamps |
| • Load at the track output | max. 2 amps     |
| • Electrical strength      | max. 40 volts   |

## Functions

- Capable of multi-protocols: fx (MM), mfx\*, and DCC
- Mode of operation set by means of DIP switches
- Addresses can be set by means of DIP switches:
  - 1-256** fx (MM) (Control Unit 6021)
  - 1-320** fx (MM) (Central Station 6021x/Mobile Station 60653)
  - 1-511** (DCC)

\* mfx not until CS2 Software Version 4.0 (2nd quarter of 2015)

- Programmable addresses by means of CVs  
**1-2.040 DCC**
- Characteristics can be changed by means of CVs
- Power supplied by means of the digital current circuit

## Signal Installation

The signal must be programmed before actually installing it.

**The following work steps may be done only when there is no voltage present:**

Setting the address and the mode of operation with the DIP switches:

- Setting the mode of operation with DIP Switch 10  
Switch 10 off = fx (MM) / mfx  
Switch 10 on = DCC
- fx (MM)/DCC Setting the address with DIP switches (See table starting on Page 22)

### **! Please note:**

- Always do settings with the DIP switches when there is no voltage present. The signal does not recognize the current switch settings until the voltage is turned on.
- Basically, 2 addresses (pairs of buttons) are required to **switch the 76496 and 76497 signals**. The second address is assigned automatically as a sequential address. This sequential address **cannot be selected at will**.

## Programming with the CS 2

### fx (MM)

The CV programming must be done on the programming track.  
**Only one signal** may be connected to the programming track **at a time**.

The following CVs can be changed in fx (MM): CV 40, 45, 46, 48 , 50, 52 and 54.

The address for the distant signal located on the mast, the next address on the 76495, on the 76496 and 76497 the address after the next **address, is assigned automatically**. This address cannot be changed.

During the programming procedure, the signal light will blink. During programming with the Central Station, by contrast the signal is switched. After the end of the programming procedure, the signal is set at "Go".

An fx dummy locomotive with the address of the signal must be entered before programming with the Mobile Station 2. Activate the signal once. After that, change the desired CV settings and switch the signal one more time.

The procedure for programming with the 6021 Control Unit can be found at [www.maerklin.de](http://www.maerklin.de) -> Tools & Downloads -> Technische Informationen.

Please see the operating instructions for the control devices in question for programming with other devices.

### DCC

CV programming must be done on the programming track. **Only one signal** may be connected to the programming track **at a time**.

The signal will blink for monitoring purposes during the data transfer.

Please see the operating instructions for the control devices in question for programming with other devices.

## CV for fx (MM) and DCC

With fx (MM) the address can be set only with the DIP switches. The values in parentheses are factory default settings.

CV	Meaning	Values	
1	Address 1 - 255	1-255 (1)	only DCC
9	Addresses 256 - 2040	0-7 (0)	only DCC
33	Number of output addresses	—	read only DCC
PoM* 40	Meaning Lighting	0 - 15 (15)	0 light off Dimming 0-15, whereby 15 = 100% brightness
PoM* 45	Signal Type Home signal: 76495 76497 76496	2 3 4	Block signal Entry signal Exit signal
PoM* 46	Signal Type Distant Signal	2 3 4	belongs to Block signal Entry signal Exit signal
PoM* 48	Home Signal Switching duration LED on/off	0 - 3	0 = 0 seconds 1 = 0.175 seconds 2 = 0.35 seconds 3 = 0.5 seconds

CV	Meaning	Values	
PoM* 50	Cross fading behavior Home signal	0 - 3	0 = simultaneously 1 = one after the other 2 = one after the other 0.1 sec. pause 3 = one after the other 0.5 sec. pause
PoM* 52	Distant Signal Switching duration LED on/off	0 - 3	0 = 0 seconds 1 = 0.175 seconds 2 = 0.35 seconds 3 = 0.5 seconds
PoM* 54	Cross fading behavior Distant Signal	0 - 3	0 = simultaneously 1 = one after the other 2 = one after the other 0.1 sec. pause 3 = one after the other 0.5 sec. pause
55	Distant Signal Address, short (like CV1) only DCC		enter the value of the home signal belonging to it (only DCC)
56	Distant Signal Address, long (like CV9) only DCC		enter the value of the home signal belonging to it (only DCC)

\*PoM programming can be done on the main track as long as it is supported by the control device.

### Setting and Calculating Addresses Greater than 255 (DCC):

Example: Address 1044 -> 1044 : 256 = 4.078125. The value before the decimal point (4) is entered in CV 9. The value after the decimal point (0.078125) is multiplied by 256  $0.078125 \times 256 = 20$ . The calculated value of 20 must be entered in CV 1.

### Sample of the correct address assignment for MM:

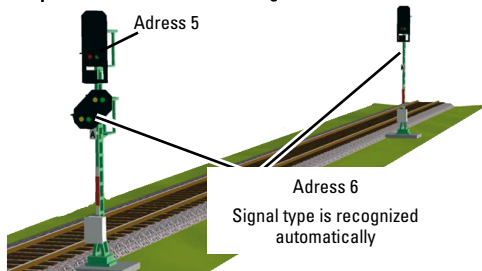

### Sample of the correct address assignment for DCC:

The address for the distant signal (CV55 / CV56) and the signal type (CV46) must correspond to the address and the signal type for the home signal following it. This is the only way to guarantee the correct reproduction of the signal aspect.

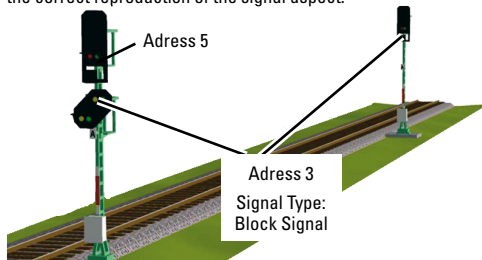

### Disposing



Products marked with a trash container with a line through it may not be disposed of at the end of their useful life in the normal household trash. They must be taken to a collection point for the recycling of electrical and electronic devices.

There is a symbol on the product, the operating instructions, or the packaging to this effect. The materials in these items can be used again according to this marking. By reusing old devices, materially recycling, or recycling in some other form of old devices such as these you make an important contribution to the protection of our environment. Please ask your city, town, community, or county authorities for the location of the appropriate disposal site.

### Warranty

The warranty card included with this product specifies the warranty conditions.

- Please contact your authorized Märklin dealer for repairs or contact:

Gebr. Märklin & Cie. GmbH  
Reparaturservice  
Stuttgarter Str. 55 - 57  
73033 Göppingen  
Germany

☎: +49 7161 608 222

E-Mail: [Service@maerklin.de](mailto:Service@maerklin.de)

## Utilisation conforme

- Le signal est conçu pour être monté sur des circuits ferroviaires miniatures numériques H0.
- Le signal ne doit être utilisé en mode analogue qu'avec un pupitre de commande 72760.
- Ne doit être utilisé que dans une pièce fermée.

## Livraison

- 1 signal
- 1 Décodeur avec plaque support
- 1 câble avec prise bipolaire, rouge et marron
- 1 câble avec prise tripolaire, rouge et rouge
- 1 câble avec connecteurs 2 pôles blanc et violet
- 1 câble avec prise tripolaire, violet, rouge-brun, rouge-vert
- 1 socle voie K avec cache
- 1 cale pour rampe
- 1 cache pour montage sous le plateau
- 1 vis 2 x 10mm
- 2 vis 2,5 x 20mm
- 4 isolations (rouge) voie C (1 pièce moulée par injection)
- 2 isolations pour conducteur central (gris) voie K
- 1 connecteur pour conducteur central voie K
- 1 image à coulisser pour la signalisation
- Instructions de montage
- Certificat de garantie

## Consignes de sécurité

- **ATTENTION !** Le matériel comporte des bords coupants et des pointes.
- Effectuer les travaux de câblage et de montage uniquement lorsque le circuit est hors tension. Dans le cas contraire, vous risquez de vous électrocuter et de vous blesser.

- **Utiliser le signal uniquement avec la tension autorisée** (cf. caractéristiques techniques).

## Consignes importantes

- Le mode d'emploi fait partie intégrante du produit. Vous devez donc la conserver et la transmettre avec le produit.
- Les mâts des signaux 76395/76397 **ne sont pas compatibles** avec ce module électronique (décodeur).
- Pour les travaux de réparation, veuillez vous adresser à votre revendeur Märklin.
- Élimination : [www.maerklin.com/en/imprint.html](http://www.maerklin.com/en/imprint.html)

## Caractéristiques techniques

- D'alimentation 16 - 20V
- Charge ≤ 100 mA
- Charge sortie voie max. 2 A
- Rigidité diélectrique max. 40 V

## Fonctions

- Multiprotocole : fx (MM), mfx\* et DCC
- Réglage du mode de fonctionnement au moyen d'un interrupteur DIP
- Adresses réglables au moyen de l'interrupteur DIP :  
**1-256** fx (MM) (Control Unit 6021)  
**1-320** fx (MM) (Central Station 6021x/Mobile Station 60653)  
**1-511** (DCC)
- Adresses programmables via CV  
**1-2.040** DCC
- Modification des propriétés via CV
- Alimentation électrique via circuit électrique numérique

\* mfx à partir de la version logicielle CS2 4.0 (2e trimestre 2015)

## Montage du signal

Avant le montage à proprement parler, vous devez programmer le signal.

**Vous réaliserez les étapes suivantes uniquement lorsque le circuit est hors tension :**

Réglage de l'adresse et du mode de fonctionnement via l'interrupteur DIP :

- Réglage du mode de fonctionnement au moyen d'un interrupteur DIP 10  
Interrupteur 10 off = fx (MM) / mfx  
Interrupteur 10 on = DCC
- fx (MM)/DCC Réglage de l'adresse via l'interrupteur DIP (tableau à partir de la page 22)

### ! Attention :

- Effectuer les réglages via l'interrupteur DIP uniquement hors tension. Le signal reconnaît les positions du commutateur dès l'activation de la tension.
- **Pour commuter les signaux réf. 76496 et 76497**, deux adresses (paires de touches) sont en principe nécessaires. La 2<sup>de</sup> adresse automatiquement attribuée est l'adresse consécutive. Cette adresse consécutive **ne peut pas être choisie librement**.

## Programmation avec CS 2

### fx (MM)

La programmation CV doit se faire au niveau de la voie de programmation. Vous ne devez brancher **qu'un seul signal** sur la voie de programmation.

Vous pouvez modifier les CV suivant dans fx (MM) : CV 40, 45, 46,

48, 50, 52 et 54.

L'adresse automatiquement attribuée pour le signal d'annonce situé sur le mât est pour 76495 l'adresse consécutive, pour 76496 et 76497, celle d'après. Cette adresse **ne peut pas être modifiée**.

Pendant la programmation, la lampe du signal clignote, et, indépendamment de cela, le signal est couplé à la Central Station pendant la programmation. Une fois la procédure de programmation terminée, le signal est mis sur « circulation ».

Avant la programmation avec la Mobile Station 2, une locomotive factice fx doit avoir été créée avec l'adresse du signal. Actionnez une fois le signal, puis accédez aux paramètres CV souhaités, modifiez-les et commutez à nouveau le signal.

Vous trouverez la procédure de programmation au moyen de la Control Unit 6021 à la page [www.maerklin.de](http://www.maerklin.de) -> Tools & Downloads -> Technische Informationen ([www.marklin.fr/fr/produits/outils/base\\_donnees\\_produits.html](http://www.marklin.fr/fr/produits/outils/base_donnees_produits.html))

Pour la programmation avec d'autres appareils, veuillez consulter les modes d'emploi des pupitres de commande correspondant.

### DCC

La programmation CV doit se faire au niveau de la voie de programmation. ne devez brancher **qu'un seul signal** sur la voie de programmation.

Pendant la transmission des données, le signal clignote pour contrôle.

Pour la programmation avec d'autres appareils, veuillez consulter les modes d'emploi des pupitres de commande correspondant.

## CV pour fx (MM) et DCC

Dans fx (MM), vous pouvez configurer l'adresse uniquement via l'interrupteur DIP. Les valeurs entre parenthèses sont les paramètres d'usine.

CV	Éclairage	Valeur	
1	Adresse 1 - 255	1-255 (1)	uniquement DCC
9	Adresses 256 - 2040	0-7 (0)	uniquement DCC
33	Nombre d'adresses de départ	—	Lire uniquement
PoM* 40	Éclairage	0 - 15 (15)	0 lumière éteinte variateur 0-15, 15 = 100% de luminosité
PoM* 45	Type de signal Signal d'exécution : 76491 76493 76494	2 3 4	Signal de block Signal d'entrée Signal de sortie
PoM* 46	Type de signal Signal d'annonc	2 3 4	Fait partie de Signal de block Signal d'entrée Signal de sortie
PoM* 48	Signal d'exécution Temps de commutation LED allumée/éteinte	0 - 3	0 = 0s 1 = 0,175s 2 = 0,35s 3 = 0,5s
PoM* 50	Signal d'annonce Passage d'une indication à l'autre	0 - 3	0 = simultanément 1 = successivement 2 = successivement avec pause 0,1s 3 = successivement avec pause 0,5s

CV	Éclairage	Valeur	
PoM* 52	Signal d'annonce Temps de commutation LED allumée/éteinte	0 - 3	0 = 0s 1 = 0,175s 2 = 0,35s 3 = 0,5s
PoM* 54	Signal d'annonce Passage d'une indication à l'autre	0 - 3	0 = simultanément 1 = successivement 2 = successivement avec pause 0,1s 3 = successivement avec pause 0,5s
55	Adresse du signal d'annonce Courte (comme CV1) uniquement DCC		Reporter la valeur du signal d'exécution correspondant (uniquement DCC)
56	Adresse du signal d'annonce longue (comme CV 9) uniquement DCC		Reporter la valeur du signal d'exécution correspondant (uniquement DCC)

\*Vous pouvez effectuer la programmation PoM, si elle est prise en charge par le pupitre de commande, sur la voie principale.

**Réglage et calcul des adresses supérieures à 255 (DCC) :** Par ex. adresse 1044 ->  $1044:256=4,078125$ . Vous devez reporter la valeur avant la virgule (4) dans CV 9. Multipliez la valeur après la virgule (0,078125) par 256  $0,078125 \times 256 = 20$ . Reportez la valeur calculée 20 dans CV 1.



### Exemple pour l'adressage correct MM:

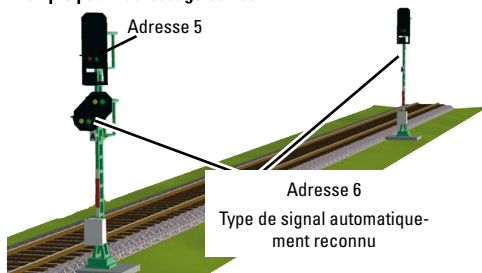

### Exemple pour l'adressage correct DCC:

L'adresse du signal d'annonce (CV55/ CV 56) et le type de signal (CV 46) doivent correspondre à l'adresse et au type de signal du signal d'exécution suivant. La reproduction correcte de l'indication du signal n'est garantie qu'à cette seule condition.

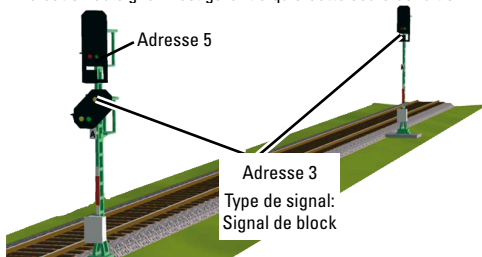

## Elimination



Indications relatives à la protection de l'environnement : Les produits marqués du signe représentant une poubelle barrée ne peuvent être éliminés en fin de vie via les ordures ménagères normales, mais doivent être remis à un centre de collecte pour le recyclage des appareils électriques et électroniques.

Le symbole figurant sur le produit lui-même, la notice d'utilisation ou l'emballage l'indique. Les matériaux sont recyclables selon leur marquage. Avec le recyclage, la récupération des matériaux ou autres formes de valorisation de vieux appareils, vous contribuez sensiblement à la protection de notre environnement. Renseignez-vous auprès de votre municipalité sur les centres compétents pour le traitement des déchets.

## Garantie

Garantie légale et garantie contractuelle conformément au bon de garantie ci-joint.

- Pour toute réparation, veuillez vous adresser à votre détaillant spécialisé Märklin ou à  
Gebr. Märklin & Cie. GmbH  
Reparaturservice  
Stuttgarter Str. 55 - 57  
73033 Göppingen / Allemagne  
☎ : +49 7161 608 222  
E-mail : Service@maerklin.de

## Beoogd gebruik

- Het sein is bestemd voor het inbouwen in H0-modelbanen.
- Het sein mag in analogebedrijf alleen in combinatie met het schakelkastje 72760 gebruikt worden.
- Het mag alleen in gesloten ruimtes gebruikt worden.

## Leveringsomvang

- 1 Sein
- 1 Decoder met houderplaat
- 1 Kabel met stekker 2-polig rood en bruin
- 1 Kabel met stekker 3-polig rood en rood
- 1 Kabel met stekker 2 polig wit en violet
- 1 Kabel met stekker 3-polig violet, rood-groen, rood-bruin
- 1 Fundament K-rail met afdekking
- 1 Stijgingswig
- 1 Afdekking voor ondervloermontage
- 1 Schroef 2 x 10mm
- 2 Schroeven 2,5 x 20mm
- 4 Isolaties (rood) C-rail (1 gietstuk)
- 2 Middenrail isolaties (grijs) K-rail
- 1 Middenrail aansluiting K-rail
- 1 Transfer voor herkenning
- Inbouwaanwijzing met sjabloon voor ondervloermontage
- Garantiebewijs

## Veiligheidsvoorschriften

- **LET OP!** Heeft vanwege de functionaliteit scherpe kanten en punten.
- Bedrading en montagewerkzaamheden alleen in spanningloze toestand uitvoeren. Als dit niet in acht genomen wordt kunt u gevaarlijke stroomschokken krijgen met de daarmee samenhangende verwondingen.
- **Het sein alleen met de toegelaten spanning** (zie technische gegevens) **gebruiken**.

## Belangrijke aanwijzingen

- De gebruiksaanwijzing is een bestandsdeel van het product en dient daarom bewaard en meegegeven worden met het product.
- De seinmasten van de seinen 76395/76397 kunnen met deze elektronica (decoder) niet gebruikt worden.
- Voor reparaties kunt u zich tot uw Märklin dealer wenden.
- Verwijderingaanwijzing: [www.maerklin.com/en/imprint.html](http://www.maerklin.com/en/imprint.html)

## Technische gegevens

- Voedingsspanning 16 - 20V
- Belasting  $\leq 100$  mA
- Belasting railuitgang max. 2 A
- Spanning max. 40 V

## Functies

- Multi-protocol geschikt voor: fx (MM) , mfx\* en DCC
- Instellen van het bedrijfssysteem met dipschakelaar
- Instelbare adressen met dipschakelaars:
  - 1-256** fx (MM) (Control Unit 6021)
  - 1-320** fx (MM) (Central Station 6021x/ Mobile Station 60653)
  - 1-511** (DCC)

\* mfx pas vanaf CS2 softwareversie 4.0 (2 de kwartaal 2015)

- Programmeerbare adressen via CV  
**1-2040 DCC**
- Veranderen van de eigenschappen via CV
- Stroomvoorziening via digitale stroomkring

## Sein inbouwen

Voor het inbouwen moet het sein eerst geprogrammeerd worden.

### De volgende werkzaamheden mogen alleen in spanningloze toestand worden uitgevoerd:

- Instellen van het adres en het bedrijfssysteem met dipschakelaar:
- Instellen van het bedrijfssysteem met dipschakelaar 10  
Schakelaar 10 off = fx (MM) / mfx  
Schakelaar 10 on = DCC
- fx (MM) / DCC instellen van het adres met dipschakelaar (tabel zie pagina 22)

### ! Let op:

- instelling met de dipschakelaar altijd in spanningloze toestand uitvoeren. Het sein herkent de actuele instelling pas na het inschakelen van de spanning.
- **Om de seinen 76496 en 76497 te kunnen schakelen zijn altijd 2 adressen (toetsenparen) nodig.** Het 2de adres wordt automatisch als vervolgadres uitgegeven. Die vervolgadres **kan niet vrij gekozen** worden.

## Programmeren met CS2

### fx (MM)

De CV programmering moet op het programmeerspoor worden uitgevoerd. Er mag **altijd maar één sein** op het programmeerspoor zijn aangesloten.

De volgende CV's kunnen bij fx (MM) veranderd worden: 40, 45, 46, 48, 50, 52 en 54.

Het adres voor het aan de mast bevestigde voorsein wordt **automatisch uitgegeven**. Dit is bij de 76495 het volgende, bij de 76496 en 76497 het daar weer opvolgende adres. Dit adres kan niet worden gewijzigd .

Tijdens het programmeren knippert het licht van het sein, afwijkend daarvan wordt tijdens het programmeren met het Central Station het sein geschakeld. Na het afsluiten van het programmeren wordt het sein in de stand "veilig" gezet.

Voor het programmeren met het Mobile Station 2 moet een fx dummie-loc worden aangemaakt met het adres van het sein. Het sein eenmaal bedienen, daarna naar gewenste CV instellingen wisselen, wijzigen en afsluitend het sein nogmaals schakelen.

De werkwijze voor het programmeren met de Control Unit 6021 vindt u op [www.maerklin.de](http://www.maerklin.de) -> Tools & Downloads -> Technische Informationen

De wijze van programmering met andere apparaten vindt u in de gebruiksaanwijzing van het desbetreffende apparaat.

### DCC

De CV programmering moet op het programmeerspoor worden uitgevoerd. Er mag **altijd maar één sein** op het programmeerspoor zijn aangesloten.

Tijdens de dataoverdracht knippert de seinverlichting ter controle.

De wijze van programmering met andere apparaten vindt u in de gebruiksaanwijzing van het desbetreffende apparaat.

## CV voor fx (MM) en DCC

Onder fx (MM) kan het adres alleen met de dipschakelaar worden ingesteld. De waarden tussen haakjes zijn de fabrieksinstellingen.

CV	Omschrijving	Waarde	
1	Adres 1 - 255	1-255 (1)	alleen DCC
9	Adres 256 - 2040	0-7 (0)	alleen DCC
33	Aantal uitgangadressen	—	alleen lezen/DCC
PoM*	40 Verlichting	0 - 15 (15)	0=licht uit, dimmen 0-15 waarbij 15 = 100% helderheid
PoM*	45 Seintype Hoofdsein		
	76495	2	Bloksein
	76497	3	Inrijdsein
	76496	4	Uitrijdsein
PoM*	46 Seintype voorsein		
		2	behoort bij Bloksein
		3	Inrijdsein
		4	Uitrijdsein
PoM*	48 Hoofdsein Omschakeltijd LED aan/uit	0 - 3	0=0s 1=0,175s 2=0,35s 3= 0,5s

CV	Omschrijving	Waarde	
50	Hoofdsein Overvloei gedrag	0 - 3	0=gelijktijdig 1=na elkaar 2=na elkaar 0,1s pauze 3=na elkaar 0,5s pauze
52	Voorsein Omschakeltijd LED aan/uit	0 - 3	0=0s 1=0,175s 2=0,35s 3= 0,5s
54	Voorsein Overvloei gedrag	0 - 3	0=gelijktijdig 1=na elkaar 2=na elkaar 0,1s pauze 3=na elkaar 0,5s pauze
55	Voorsein adres kort (als CV1) alleen DCC		Waarde van het daarbij behorende hoofdsein invoeren (alleen DCC)
56	Voorsein adres lang (als CV9) alleen DCC		Waarde van het daarbij behorende hoofdsein invoeren (alleen DCC)

\* PoM programmeren kan, voor zover het besturingsapparaat dit ondersteund, op het hoofdspoor gebeuren.

### Instellen en berekenen van de adressen groter dan 255 (DCC):

Bijv. adres 144 -> 1044:256= 4,078125. De waarde voor de komma (4) moet in CV 9 ingevoerd worden. De waarde na de komma (0,078125) wordt met 256 vermenigvuldigd, 078125x256=20. De berekende waarde (20) wordt in CV 1 ingevoerd.

### Voorbeeld voor de juiste adressering MM:

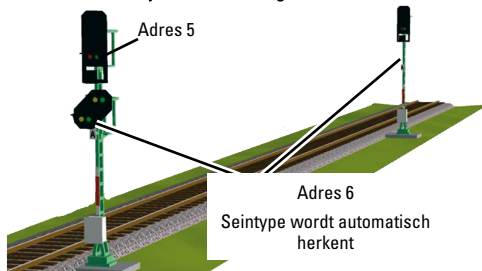

### Voorbeeld voor de juiste adressering DCC:

Het adres van het voorsein (CV 55 / CV56) en het seintype (CV 46) moet overeenkomen met het adres en het seintype van het daarop volgende hoofdsein. Alleen dan kan het juiste seinbeeld weergegeven worden.

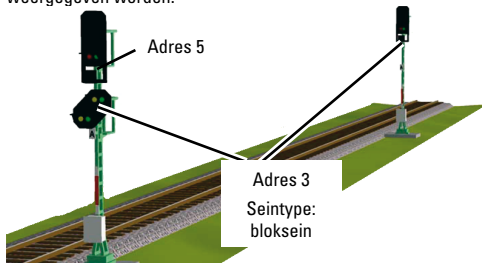

## Afdanken

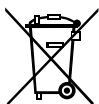

Milieu-informatie: producten, die met de doorgestreepte afvalcontainer zijn gemarkeerd, mogen aan het einde van hun levensduur niet met het normale huisvuil meegegeven worden, maar moeten op een verzamelpunt voor de recycling van elektrische en elektronische apparatuur afgegeven worden. Het symbool op het product, op de handleiding of op de verpakking geeft dit aan. De materialen worden gerecycled in overeenstemming met hun identificatie. Met het hergebruik van de grondstoffen of andere vormen van het hergebruik van oude apparatuur levert u een belangrijke bijdrage aan de bescherming van ons milieu. Neem contact op met uw gemeente voor een bevoegde plaatselijke inzamelplaats.

## Garantie

Waarborg en garantie volgens bijgevoegd garantiebewijs.

- Voor reparaties kunt u zich wenden tot uw Märklin dealer of tot  
Gebr. Märklin & Cie. GmbH  
Reparaturservice  
Stuttgarter Str. 55 - 57  
73033 Göppingen  
Germany  
Tel: +49 7161 608 222  
E-Mail: Service@maerklin.de



## Betriebsart und Adressen einstellen



### Setting the mode of operation and addresses

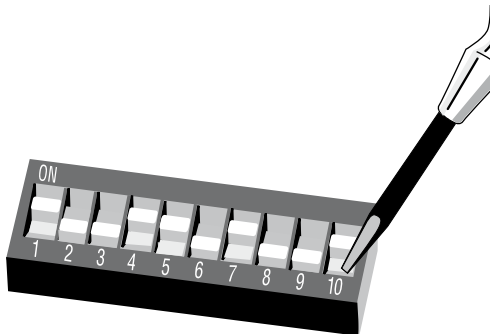

### Définir le mode d'exploitation et les adresses



### Bedrijfsmodus en adres instellen





				10 (0/1)					
1	1	1	1						fx (MM)/DCC
2	1	2	2						fx (MM)/DCC
3	1	3	1 2						fx (MM)/DCC
4	1	4	3						fx (MM)/DCC
5	1	5	1 3						fx (MM)/DCC
6	1	6	2 3						fx (MM)/DCC
7	1	7	1 2 3						fx (MM)/DCC
8	1	8	4						fx (MM)/DCC
9	1	9	1 4						fx (MM)/DCC
10	1	10	2 4						fx (MM)/DCC
11	1	11	1 2 4						fx (MM)/DCC
12	1	12	3 4						fx (MM)/DCC
13	1	13	1 3 4						fx (MM)/DCC
14	1	14	2 3 4						fx (MM)/DCC
15	1	15	1 2 3 4						fx (MM)/DCC
16	1	16	5						fx (MM)/DCC
17	2	1	1 5						fx (MM)/DCC
18	2	2	2 5						fx (MM)/DCC
19	2	3	1 2 5						fx (MM)/DCC
20	2	4	3 5						fx (MM)/DCC
21	2	5	1 3 5						fx (MM)/DCC
22	2	6	2 3 5						fx (MM)/DCC
23	2	7	1 2 3 5						fx (MM)/DCC
24	2	8	4 5						fx (MM)/DCC
25	2	9	1 4 5						fx (MM)/DCC
26	2	10	2 4 5						fx (MM)/DCC



				10 (0/1)				
27		2 11	1 2 4 5				fx (MM)/DCC	
28		2 12	3 4 5				fx (MM)/DCC	
29		2 13	1 3 4 5				fx (MM)/DCC	
30		2 14	2 3 4 5				fx (MM)/DCC	
31		2 15	1 2 3 4 5				fx (MM)/DCC	
32		2 16			6		fx (MM)/DCC	
33		3 1 1			6		fx (MM)/DCC	
34		3 2 2			6		fx (MM)/DCC	
35		3 3 1 2			6		fx (MM)/DCC	
36		3 4 3			6		fx (MM)/DCC	
37		3 5 1 3			6		fx (MM)/DCC	
38		3 6 2 3			6		fx (MM)/DCC	
39		3 7 1 2 3			6		fx (MM)/DCC	
40		3 8 4			6		fx (MM)/DCC	
41		3 9 1 4			6		fx (MM)/DCC	
42		3 10 2 4			6		fx (MM)/DCC	
43		3 11 1 2 4			6		fx (MM)/DCC	
44		3 12 3 4			6		fx (MM)/DCC	
45		3 13 1 3 4			6		fx (MM)/DCC	
46		3 14 2 3 4			6		fx (MM)/DCC	
47		3 15 1 2 3 4			6		fx (MM)/DCC	
48		3 16 5 6					fx (MM)/DCC	
49		4 1 1 5 6					fx (MM)/DCC	
50		4 2 2 5 6					fx (MM)/DCC	
51		4 3 1 2 5 6					fx (MM)/DCC	



				10 (0/1)				
52		4 4	3 5 6				fx (MM)/DCC	
53		4 5 1 3	5 6				fx (MM)/DCC	
54		4 6 2 3	5 6				fx (MM)/DCC	
55		4 7 1 2 3	5 6				fx (MM)/DCC	
56		4 8 4 5 6					fx (MM)/DCC	
57		4 9 1 4 5 6					fx (MM)/DCC	
58		4 10 2 4 5 6					fx (MM)/DCC	
59		4 11 1 2 4 5 6					fx (MM)/DCC	
60		4 12 3 4 5 6					fx (MM)/DCC	
61		4 13 1 3 4 5 6					fx (MM)/DCC	
62		4 14 2 3 4 5 6					fx (MM)/DCC	
63		4 15 1 2 3 4 5 6					fx (MM)/DCC	
64		4 16 7					fx (MM)/DCC	
65		5 1 1 7					fx (MM)/DCC	
66		5 2 2 7					fx (MM)/DCC	
67		5 3 1 2 7					fx (MM)/DCC	
68		5 4 3 7					fx (MM)/DCC	
69		5 5 1 3 7					fx (MM)/DCC	
70		5 6 2 3 7					fx (MM)/DCC	
71		5 7 1 2 3 7					fx (MM)/DCC	
72		5 8 4 7					fx (MM)/DCC	
73		5 9 1 4 7					fx (MM)/DCC	
74		5 10 2 4 7					fx (MM)/DCC	
75		5 11 1 2 4 7					fx (MM)/DCC	
76		5 12 3 4 7					fx (MM)/DCC	



										
			10 (0/1)							
77		5 13	1	3 4				7	fx (MM)/DCC	
78		5 14		2 3 4				7	fx (MM)/DCC	
79		5 15	1 2 3 4					7	fx (MM)/DCC	
80		5 16			5			7	fx (MM)/DCC	
81		6 1	1			5		7	fx (MM)/DCC	
82		6 2		2		5		7	fx (MM)/DCC	
83		6 3	1 2			5		7	fx (MM)/DCC	
84		6 4			3			5 7	fx (MM)/DCC	
85		6 5	1		3			5 7	fx (MM)/DCC	
86		6 6		2 3		5		7	fx (MM)/DCC	
87		6 7	1 2 3			5		7	fx (MM)/DCC	
88		6 8			4 5			7	fx (MM)/DCC	
89		6 9	1		4 5			7	fx (MM)/DCC	
90		6 10		2		4 5		7	fx (MM)/DCC	
91		6 11	1 2			4 5		7	fx (MM)/DCC	
92		6 12			3 4 5			7	fx (MM)/DCC	
93		6 13	1		3 4 5			7	fx (MM)/DCC	
94		6 14		2 3 4 5				7	fx (MM)/DCC	
95		6 15	1 2 3 4 5					7	fx (MM)/DCC	
96		6 16				6 7			fx (MM)/DCC	
97		7 1	1				6 7		fx (MM)/DCC	
98		7 2		2			6 7		fx (MM)/DCC	
99		7 3	1 2				6 7		fx (MM)/DCC	
100		7 4			3			6 7	fx (MM)/DCC	
101		7 5	1		3			6 7	fx (MM)/DCC	



										
			10 (0/1)							
102		7 6		2 3				6 7	fx (MM)/DCC	
103		7 7	1 2 3					6 7	fx (MM)/DCC	
104		7 8			4			6 7	fx (MM)/DCC	
105		7 9	1		4			6 7	fx (MM)/DCC	
106		7 10		2		4		6 7	fx (MM)/DCC	
107		7 11	1 2		4			6 7	fx (MM)/DCC	
108		7 12			3 4			6 7	fx (MM)/DCC	
109		7 13	1		3 4			6 7	fx (MM)/DCC	
110		7 14		2 3 4				6 7	fx (MM)/DCC	
111		7 15	1 2 3 4					6 7	fx (MM)/DCC	
112		7 16				5		6 7	fx (MM)/DCC	
113		8 1	1			5		6 7	fx (MM)/DCC	
114		8 2		2		5		6 7	fx (MM)/DCC	
115		8 3	1 2			5		6 7	fx (MM)/DCC	
116		8 4			3		5	6 7	fx (MM)/DCC	
117		8 5	1		3		5	6 7	fx (MM)/DCC	
118		8 6		2 3		5		6 7	fx (MM)/DCC	
119		8 7	1 2 3			5		6 7	fx (MM)/DCC	
120		8 8			4		5	6 7	fx (MM)/DCC	
121		8 9	1		4		5	6 7	fx (MM)/DCC	
122		8 10		2		4		5 6 7	fx (MM)/DCC	
123		8 11	1 2			4		5 6 7	fx (MM)/DCC	
124		8 12			3		4	5 6 7	fx (MM)/DCC	
125		8 13	1		3		4	5 6 7	fx (MM)/DCC	
126		8 14		2 3 4				5 6 7	fx (MM)/DCC	
127		8 15	1 2 3 4					5 6 7	fx (MM)/DCC	









										10 (0/1)
128	8	16						8	fx (MM)/DCC	
129	9	1	1					8	fx (MM)/DCC	
130	9	2		2				8	fx (MM)/DCC	
131	9	3	1	2				8	fx (MM)/DCC	
132	9	4			3			8	fx (MM)/DCC	
133	9	5	1	3	3			8	fx (MM)/DCC	
134	9	6		2	3			8	fx (MM)/DCC	
135	9	7	1	2	3			8	fx (MM)/DCC	
136	9	8				4		8	fx (MM)/DCC	
137	9	9	1			4		8	fx (MM)/DCC	
138	9	10		2		4		8	fx (MM)/DCC	
139	9	11	1	2		4		8	fx (MM)/DCC	
140	9	12			3	4		8	fx (MM)/DCC	
141	9	13	1		3	4		8	fx (MM)/DCC	
142	9	14		2	3	4		8	fx (MM)/DCC	
143	9	15	1	2	3	4		8	fx (MM)/DCC	
144	9	16					5	8	fx (MM)/DCC	
145	10	1	1				5	8	fx (MM)/DCC	
146	10	2		2			5	8	fx (MM)/DCC	
147	10	3	1	2			5	8	fx (MM)/DCC	
148	10	4			3		5	8	fx (MM)/DCC	
149	10	5	1		3		5	8	fx (MM)/DCC	
150	10	6		2	3		5	8	fx (MM)/DCC	
151	10	7	1	2	3		5	8	fx (MM)/DCC	
152	10	8				4	5	8	fx (MM)/DCC	
153	10	9	1			4	5	8	fx (MM)/DCC	



										10 (0/1)	
154	10	10		2		4	5		8	fx (MM)/DCC	
155	10	11	1	2		4	5		8	fx (MM)/DCC	
156	10	12			3	4	5		8	fx (MM)/DCC	
157	10	13	1		3	4	5		8	fx (MM)/DCC	
158	10	14		2	3	4	5		8	fx (MM)/DCC	
159	10	15	1	2	3	4	5		8	fx (MM)/DCC	
160	10	16						6	8	fx (MM)/DCC	
161	11	1	1					6	8	fx (MM)/DCC	
162	11	2		2				6	8	fx (MM)/DCC	
163	11	3	1	2				6	8	fx (MM)/DCC	
164	11	4				3		6	8	fx (MM)/DCC	
165	11	5	1			3		6	8	fx (MM)/DCC	
166	11	6		2	3			6	8	fx (MM)/DCC	
167	11	7	1	2	3			6	8	fx (MM)/DCC	
168	11	8					4	6	8	fx (MM)/DCC	
169	11	9	1				4	6	8	fx (MM)/DCC	
170	11	10		2			4	6	8	fx (MM)/DCC	
171	11	11	1	2			4	6	8	fx (MM)/DCC	
172	11	12				3	4	6	8	fx (MM)/DCC	
173	11	13	1		3	4		6	8	fx (MM)/DCC	
174	11	14		2	3	4		6	8	fx (MM)/DCC	
175	11	15	1	2	3	4		6	8	fx (MM)/DCC	
176	11	16						5	6	8	fx (MM)/DCC
177	12	1	1					5	6	8	fx (MM)/DCC
178	12	2		2				5	6	8	fx (MM)/DCC
179	12	3	1	2				5	6	8	fx (MM)/DCC



										
			10 (0/1)							
180		12 4		3	5 6	8		fx (MM)/DCC		
181		12 5	1	3	5 6	8		fx (MM)/DCC		
182		12 6		2 3	5 6	8		fx (MM)/DCC		
183		12 7	1 2 3		5 6	8		fx (MM)/DCC		
184		12 8			4 5 6	8		fx (MM)/DCC		
185		12 9	1		4 5 6	8		fx (MM)/DCC		
186		12 10		2	4 5 6	8		fx (MM)/DCC		
187		12 11	1 2		4 5 6	8		fx (MM)/DCC		
188		12 12			3 4 5 6	8		fx (MM)/DCC		
189		12 13	1		3 4 5 6	8		fx (MM)/DCC		
190		12 14		2 3	4 5 6	8		fx (MM)/DCC		
191		12 15	1 2 3	4 5 6		8		fx (MM)/DCC		
192		12 16				7 8		fx (MM)/DCC		
193		13 1	1			7 8		fx (MM)/DCC		
194		13 2		2		7 8		fx (MM)/DCC		
195		13 3	1 2			7 8		fx (MM)/DCC		
196		13 4			3	7 8		fx (MM)/DCC		
197		13 5	1		3	7 8		fx (MM)/DCC		
198		13 6		2 3		7 8		fx (MM)/DCC		
199		13 7	1 2 3			7 8		fx (MM)/DCC		
200		13 8			4	7 8		fx (MM)/DCC		
201		13 9	1		4	7 8		fx (MM)/DCC		
202		13 10		2	4	7 8		fx (MM)/DCC		
203		13 11	1 2		4	7 8		fx (MM)/DCC		
204		13 12			3 4	7 8		fx (MM)/DCC		
205		13 13	1		3 4	7 8		fx (MM)/DCC		



										
			10 (0/1)							
206		13 14		2 3 4		7 8		fx (MM)/DCC		
207		13 15	1 2 3 4			7 8		fx (MM)/DCC		
208		13 16			5	7 8		fx (MM)/DCC		
209		14 1	1			5 7 8		fx (MM)/DCC		
210		14 2		2		5 7 8		fx (MM)/DCC		
211		14 3	1 2			5 7 8		fx (MM)/DCC		
212		14 4			3	5 7 8		fx (MM)/DCC		
213		14 5	1		3	5 7 8		fx (MM)/DCC		
214		14 6		2 3		5 7 8		fx (MM)/DCC		
215		14 7	1 2 3			5 7 8		fx (MM)/DCC		
216		14 8			4 5	7 8		fx (MM)/DCC		
217		14 9	1		4 5	7 8		fx (MM)/DCC		
218		14 10		2	4 5	7 8		fx (MM)/DCC		
219		14 11	1 2		4 5	7 8		fx (MM)/DCC		
220		14 12			3 4 5	7 8		fx (MM)/DCC		
221		14 13	1		3 4 5	7 8		fx (MM)/DCC		
222		14 14		2 3	4 5	7 8		fx (MM)/DCC		
223		14 15	1 2 3	4 5		7 8		fx (MM)/DCC		
224		14 16				6 7 8		fx (MM)/DCC		
225		15 1	1			6 7 8		fx (MM)/DCC		
226		15 2		2		6 7 8		fx (MM)/DCC		
227		15 3	1 2			6 7 8		fx (MM)/DCC		
228		15 4			3	6 7 8		fx (MM)/DCC		
229		15 5	1		3	6 7 8		fx (MM)/DCC		
230		15 6		2 3		6 7 8		fx (MM)/DCC		
231		15 7	1 2 3			6 7 8		fx (MM)/DCC		



										10 (0/1)	
232	15	8			4	6	7	8	fx (MM)/DCC		
233	15	9	1		4	6	7	8	fx (MM)/DCC		
234	15	10		2	4	6	7	8	fx (MM)/DCC		
235	15	11	1	2	4	6	7	8	fx (MM)/DCC		
236	15	12			3	4	6	7	8	fx (MM)/DCC	
237	15	13	1		3	4	6	7	8	fx (MM)/DCC	
238	15	14		2	3	4	6	7	8	fx (MM)/DCC	
239	15	15	1	2	3	4		6	7	8	fx (MM)/DCC
240	15	16				5	6	7	8	fx (MM)/DCC	
241	16	1	1			5	6	7	8	fx (MM)/DCC	
242	16	2		2		5	6	7	8	fx (MM)/DCC	
243	16	3	1	2		5	6	7	8	fx (MM)/DCC	
244	16	4			3	5	6	7	8	fx (MM)/DCC	
245	16	5	1		3	5	6	7	8	fx (MM)/DCC	
246	16	6		2	3	5	6	7	8	fx (MM)/DCC	
247	16	7	1	2	3	5	6	7	8	fx (MM)/DCC	
248	16	8			4	5	6	7	8	fx (MM)/DCC	
249	16	9	1		4	5	6	7	8	fx (MM)/DCC	
250	16	10		2	4	5	6	7	8	fx (MM)/DCC	
251	16	11	1	2	4	5	6	7	8	fx (MM)/DCC	
252	16	12			3	4	5	6	7	8	fx (MM)/DCC
253	16	13	1		3	4	5	6	7	8	fx (MM)/DCC
254	16	14		2	3	4	5	6	7	8	fx (MM)/DCC
255	16	15	1	2	3	4	5	6	7	8	fx (MM)/DCC
256	16	16							9	fx (MM)/DCC	
257	17	1	1						9	fx (MM)/DCC	



										10 (0/1)	
258	17	2			2					9	fx (MM)/DCC
259	17	3	1	2						9	fx (MM)/DCC
260	17	4					3			9	fx (MM)/DCC
261	17	5	1				3			9	fx (MM)/DCC
262	17	6			2	3				9	fx (MM)/DCC
263	17	7	1	2	3					9	fx (MM)/DCC
264	17	8						4		9	fx (MM)/DCC
265	17	9	1					4		9	fx (MM)/DCC
266	17	10			2			4		9	fx (MM)/DCC
267	17	11	1	2				4		9	fx (MM)/DCC
268	17	12					3	4		9	fx (MM)/DCC
269	17	13	1				3	4		9	fx (MM)/DCC
270	17	14			2	3	4			9	fx (MM)/DCC
271	17	15	1	2	3	4				9	fx (MM)/DCC
272	17	16						5		9	fx (MM)/DCC
273	18	1	1					5		9	fx (MM)/DCC
274	18	2			2			5		9	fx (MM)/DCC
275	18	3	1	2				5		9	fx (MM)/DCC
276	18	4					3	5		9	fx (MM)/DCC
277	18	5	1				3	5		9	fx (MM)/DCC
278	18	6			2	3		5		9	fx (MM)/DCC
279	18	7	1	2	3			5		9	fx (MM)/DCC
280	18	8						4	5	9	fx (MM)/DCC
281	18	9	1					4	5	9	fx (MM)/DCC
282	18	10			2			4	5	9	fx (MM)/DCC
283	18	11	1	2				4	5	9	fx (MM)/DCC



													
			10 (0/1)										
284	18	12			3	4	5					9	fx (MM)/DCC
285	18	13	1		3	4	5					9	fx (MM)/DCC
286	18	14		2	3	4	5					9	fx (MM)/DCC
287	18	15	1	2	3	4	5					9	fx (MM)/DCC
288	18	16						6				9	fx (MM)/DCC
289	19	1	1					6				9	fx (MM)/DCC
290	19	2		2				6				9	fx (MM)/DCC
291	19	3	1	2				6				9	fx (MM)/DCC
292	19	4			3			6				9	fx (MM)/DCC
293	19	5	1		3			6				9	fx (MM)/DCC
294	19	6		2	3			6				9	fx (MM)/DCC
295	19	7	1	2	3			6				9	fx (MM)/DCC
296	19	8			4			6				9	fx (MM)/DCC
297	19	9	1		4			6				9	fx (MM)/DCC
298	19	10		2	4			6				9	fx (MM)/DCC
299	19	11	1	2	4			6				9	fx (MM)/DCC
300	19	12			3	4		6				9	fx (MM)/DCC
301	19	13	1		3	4		6				9	fx (MM)/DCC
302	19	14		2	3	4		6				9	fx (MM)/DCC
303	19	15	1	2	3	4		6				9	fx (MM)/DCC
304	19	16					5	6				9	fx (MM)/DCC
305	20	1	1				5	6				9	fx (MM)/DCC
306	20	2		2			5	6				9	fx (MM)/DCC
307	20	3	1	2			5	6				9	fx (MM)/DCC
308	20	4			3		5	6				9	fx (MM)/DCC
309	20	5	1		3		5	6				9	fx (MM)/DCC



													
			10 (0/1)										
310	20	6			2	3			5	6		9	fx (MM)/DCC
311	20	7	1	2	3				4	5	6	9	fx (MM)/DCC
312	20	8							4	5	6	9	fx (MM)/DCC
313	20	9	1						4	5	6	9	fx (MM)/DCC
314	20	10		2					4	5	6	9	fx (MM)/DCC
315	20	11	1	2					4	5	6	9	fx (MM)/DCC
316	20	12			3	4			4	5	6	9	fx (MM)/DCC
317	20	13	1		3	4			4	5	6	9	fx (MM)/DCC
318	20	14		2	3	4			4	5	6	9	fx (MM)/DCC
319	20	15	1	2	3	4			4	5	6	9	fx (MM)/DCC
320	20	16								7		9	fx (MM)/DCC
321	21	1	1							7		9	---/DCC
322	21	2		2						7		9	---/DCC
323	21	3	1	2						7		9	---/DCC
324	21	4				3				7		9	---/DCC
325	21	5	1			3				7		9	---/DCC
326	21	6			2	3				7		9	---/DCC
327	21	7	1	2	3					7		9	---/DCC
328	21	8							4		7	9	---/DCC
329	21	9	1						4		7	9	---/DCC
330	21	10			2				4		7	9	---/DCC
331	21	11	1	2					4		7	9	---/DCC
332	21	12				3	4			7		9	---/DCC
333	21	13	1			3	4			7		9	---/DCC
334	21	14			2	3	4			7		9	---/DCC
335	21	15	1	2	3	4				7		9	---/DCC



										10 (0/1)
336		21 16			5	7	9	---	DCC	
337		22 1	1		5	7	9	---	DCC	
338		22 2		2	5	7	9	---	DCC	
339		22 3	1 2		5	7	9	---	DCC	
340		22 4		3	5	7	9	---	DCC	
341		22 5	1	3	5	7	9	---	DCC	
342		22 6		2 3	5	7	9	---	DCC	
343		22 7	1 2 3		5	7	9	---	DCC	
344		22 8			4 5	7	9	---	DCC	
345		22 9	1		4 5	7	9	---	DCC	
346		22 10		2	4 5	7	9	---	DCC	
347		22 11	1 2		4 5	7	9	---	DCC	
348		22 12			3 4 5	7	9	---	DCC	
349		22 13	1		3 4 5	7	9	---	DCC	
350		22 14		2 3 4 5	7	9	---	DCC		
351		22 15	1 2 3 4 5		7	9	---	DCC		
352		22 16			6 7	9	---	DCC		
353		23 1	1		6 7	9	---	DCC		
354		23 2		2	6 7	9	---	DCC		
355		23 3	1 2		6 7	9	---	DCC		
356		23 4			3	6 7	9	---	DCC	
357		23 5	1		3	6 7	9	---	DCC	
358		23 6		2 3	6 7	9	---	DCC		
359		23 7	1 2 3		6 7	9	---	DCC		
360		23 8			4	6 7	9	---	DCC	
361		23 9	1		4	6 7	9	---	DCC	



										10 (0/1)
362		23 10		2	4	6 7	9	---	DCC	
363		23 11	1 2		4	6 7	9	---	DCC	
364		23 12			3 4	6 7	9	---	DCC	
365		23 13	1		3 4	6 7	9	---	DCC	
366		23 14		2 3 4	6 7	9	---	DCC		
367		23 15	1 2 3 4		6 7	9	---	DCC		
368		23 16				5 6 7	9	---	DCC	
369		24 1	1			5 6 7	9	---	DCC	
370		24 2		2		5 6 7	9	---	DCC	
371		24 3	1 2			5 6 7	9	---	DCC	
372		24 4			3	5 6 7	9	---	DCC	
373		24 5	1		3	5 6 7	9	---	DCC	
374		24 6		2 3		5 6 7	9	---	DCC	
375		24 7	1 2 3			5 6 7	9	---	DCC	
376		24 8				4 5 6 7	9	---	DCC	
377		24 9	1			4 5 6 7	9	---	DCC	
378		24 10		2		4 5 6 7	9	---	DCC	
379		24 11	1 2			4 5 6 7	9	---	DCC	
380		24 12			3 4	5 6 7	9	---	DCC	
381		24 13	1		3 4	5 6 7	9	---	DCC	
382		24 14		2 3 4	5 6 7	9	---	DCC		
383		24 15	1 2 3 4	5 6 7		9	---	DCC		
384		24 16					8 9	---	DCC	
385		25 1	1				8 9	---	DCC	
386		25 2		2			8 9	---	DCC	
387		25 3	1 2				8 9	---	DCC	

																	
			10 (0/1)														
388	25	4								3						8 9	---/DCC
389	25	5	1							3						8 9	---/DCC
390	25	6			2	3										8 9	---/DCC
391	25	7	1	2	3											8 9	---/DCC
392	25	8					4									8 9	---/DCC
393	25	9	1				4									8 9	---/DCC
394	25	10		2			4									8 9	---/DCC
395	25	11	1	2			4									8 9	---/DCC
396	25	12				3	4									8 9	---/DCC
397	25	13	1			3	4									8 9	---/DCC
398	25	14		2	3	4										8 9	---/DCC
399	25	15	1	2	3	4										8 9	---/DCC
400	25	16						5								8 9	---/DCC
401	26	1	1					5								8 9	---/DCC
402	26	2		2				5								8 9	---/DCC
403	26	3	1	2				5								8 9	---/DCC
404	26	4			3	5										8 9	---/DCC
405	26	5	1		3	5										8 9	---/DCC
406	26	6		2	3	5										8 9	---/DCC
407	26	7	1	2	3		5									8 9	---/DCC
408	26	8				4	5									8 9	---/DCC
409	26	9	1			4	5									8 9	---/DCC
410	26	10		2		4	5									8 9	---/DCC
411	26	11	1	2		4	5									8 9	---/DCC
412	26	12			3	4	5									8 9	---/DCC
413	26	13	1		3	4	5									8 9	---/DCC

																
			10 (0/1)													
414	26	14			2	3	4	5							8 9	---/DCC
415	26	15	1	2	3	4	5								8 9	---/DCC
416	26	16							6						8 9	---/DCC
417	27	1	1						6						8 9	---/DCC
418	27	2		2					6						8 9	---/DCC
419	27	3	1	2					6						8 9	---/DCC
420	27	4				3			6						8 9	---/DCC
421	27	5	1			3			6						8 9	---/DCC
422	27	6		2	3				6						8 9	---/DCC
423	27	7	1	2	3				6						8 9	---/DCC
424	27	8					4		6						8 9	---/DCC
425	27	9	1			4			6						8 9	---/DCC
426	27	10		2		4			6						8 9	---/DCC
427	27	11	1	2		4			6						8 9	---/DCC
428	27	12			3	4			6						8 9	---/DCC
429	27	13	1		3	4			6						8 9	---/DCC
430	27	14		2	3	4			6						8 9	---/DCC
431	27	15	1	2	3	4			6						8 9	---/DCC
432	27	16							5	6					8 9	---/DCC
433	28	1	1						5	6					8 9	---/DCC
434	28	2		2					5	6					8 9	---/DCC
435	28	3	1	2					5	6					8 9	---/DCC
436	28	4				3			5	6					8 9	---/DCC
437	28	5	1			3			5	6					8 9	---/DCC
438	28	6		2	3				5	6					8 9	---/DCC
439	28	7	1	2	3				5	6					8 9	---/DCC

										10 (0/1)		
440	28	8			4	5	6	8	9	---/DCC		
441	28	9	1		4	5	6	8	9	---/DCC		
442	28	10		2	4	5	6	8	9	---/DCC		
443	28	11	1	2	4	5	6	8	9	---/DCC		
444	28	12			3	4	5	6	8	9	---/DCC	
445	28	13	1		3	4	5	6	8	9	---/DCC	
446	28	14		2	3	4	5	6	8	9	---/DCC	
447	28	15	1	2	3	4	5	6	8	9	---/DCC	
448	28	16							7	8	9	---/DCC
449	29	1	1						7	8	9	---/DCC
450	29	2		2					7	8	9	---/DCC
451	29	3	1	2					7	8	9	---/DCC
452	29	4			3				7	8	9	---/DCC
453	29	5	1		3				7	8	9	---/DCC
454	29	6		2	3				7	8	9	---/DCC
455	29	7	1	2	3				7	8	9	---/DCC
456	29	8				4			7	8	9	---/DCC
457	29	9	1			4			7	8	9	---/DCC
458	29	10		2		4			7	8	9	---/DCC
459	29	11	1	2		4			7	8	9	---/DCC
460	29	12			3	4			7	8	9	---/DCC
461	29	13	1		3	4			7	8	9	---/DCC
462	29	14		2	3	4			7	8	9	---/DCC
463	29	15	1	2	3	4			7	8	9	---/DCC
464	29	16					5		7	8	9	---/DCC
465	30	1	1				5		7	8	9	---/DCC

										10 (0/1)		
466	30	2		2			5	7	8	9	---/DCC	
467	30	3	1	2			5	7	8	9	---/DCC	
468	30	4			3		5	7	8	9	---/DCC	
469	30	5	1		3		5	7	8	9	---/DCC	
470	30	6		2	3		5	7	8	9	---/DCC	
471	30	7	1	2	3		5	7	8	9	---/DCC	
472	30	8					4	5	7	8	9	---/DCC
473	30	9	1				4	5	7	8	9	---/DCC
474	30	10		2			4	5	7	8	9	---/DCC
475	30	11	1	2			4	5	7	8	9	---/DCC
476	30	12			3	4	5	7	8	9	---/DCC	
477	30	13	1		3	4	5	7	8	9	---/DCC	
478	30	14		2	3	4	5	7	8	9	---/DCC	
479	30	15	1	2	3	4	5	7	8	9	---/DCC	
480	30	16						6	7	8	9	---/DCC
481	31	1	1					6	7	8	9	---/DCC
482	31	2		2				6	7	8	9	---/DCC
483	31	3	1	2				6	7	8	9	---/DCC
484	31	4				3		6	7	8	9	---/DCC
485	31	5	1			3		6	7	8	9	---/DCC
486	31	6		2	3			6	7	8	9	---/DCC
487	31	7	1	2	3			6	7	8	9	---/DCC
488	31	8					4	6	7	8	9	---/DCC
489	31	9	1				4	6	7	8	9	---/DCC
490	31	10		2			4	6	7	8	9	---/DCC
491	31	11	1	2			4	6	7	8	9	---/DCC

												
											10 (0/1)	
492	31	12			3	4		6	7	8	9	--- / DCC
493	31	13	1		3	4		6	7	8	9	--- / DCC
494	31	14		2	3	4		6	7	8	9	--- / DCC
495	31	15	1	2	3	4		6	7	8	9	--- / DCC
496	31	16					5	6	7	8	9	--- / DCC
497	32	1	1				5	6	7	8	9	--- / DCC
498	32	2		2			5	6	7	8	9	--- / DCC
499	32	3	1	2			5	6	7	8	9	--- / DCC
500	32	4			3		5	6	7	8	9	--- / DCC
501	32	5	1		3		5	6	7	8	9	--- / DCC
502	32	6		2	3		5	6	7	8	9	--- / DCC
503	32	7	1	2	3		5	6	7	8	9	--- / DCC
504	32	8				4	5	6	7	8	9	--- / DCC
505	32	9	1			4	5	6	7	8	9	--- / DCC
506	32	10		2		4	5	6	7	8	9	--- / DCC
507	32	11	1	2		4	5	6	7	8	9	--- / DCC
508	32	12			3	4	5	6	7	8	9	--- / DCC
509	32	13	1		3	4	5	6	7	8	9	--- / DCC
510	32	14		2	3	4	5	6	7	8	9	--- / DCC
511	32	15	1	2	3	4	5	6	7	8	9	--- / DCC

Adressen größer 511 können nur im DCC Format ausgegeben werden und müssen mit der CV Programmierung über das Programmiergleis durchgeführt werden.

Addresses larger than 511 can only be assigned in the DCC format and must be done by programming a CV using the programming track.

Les adresses supérieures à 511 peuvent uniquement être éditées dans le format DCC et doivent être exécutées avec la programmation des CV via la voie de programmation.

Adressen groter dan 511 kunnen alleen in het DCC formaat gebruikt worden en moeten met de CV programmering via het programmeerspoor ingesteld worden.



## Aufbau • Setup • Montage • Opbouwen

### Kabelfarben

- 1 rot / red / rouge / rood /
- 2 braun / brown / brun / bruin
- 3 gelb / yellow / jaune / geel
- 4 violett / violett/violet / paars
- 5 rot-braun / red-brown / rouge-brun / rood-bruin
- 6 rot-grün / red-green/ rouge-vert / rood-groen
- 7 weiß / white / blanc / wit

Anschluss Programmiergleis  
Connections for the Programming Track  
Branchement voie de programmation  
Aansluiten op het programmeerspoor

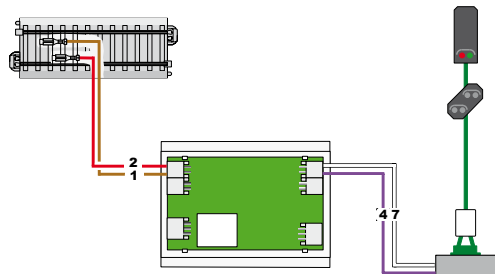

Decoder in das C-Gleis einbauen

Installing Decoders in C Track

Intégration du décodeur dans la voie C

Decoder onder de C-rail inbouwen

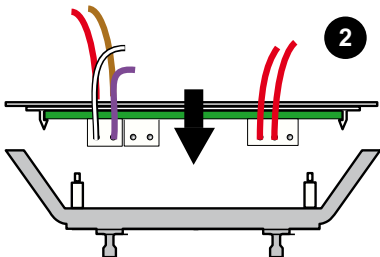
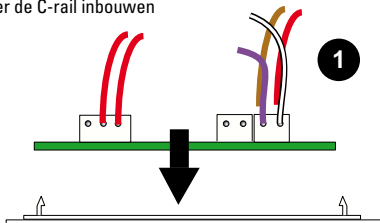

Unterflurmontage des Decoders:

Below-baseboard installation of the decoder:

Montage du décodeur sous le plateau

Ondervloermontage van de decoder

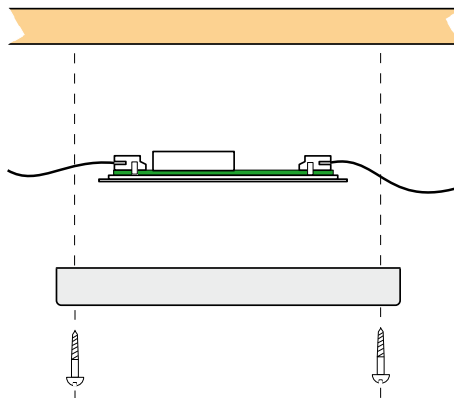

Befestigung am C-Gleis • Installation with C Track • Fixation à la voie C • Bevestiging aan C-rail •

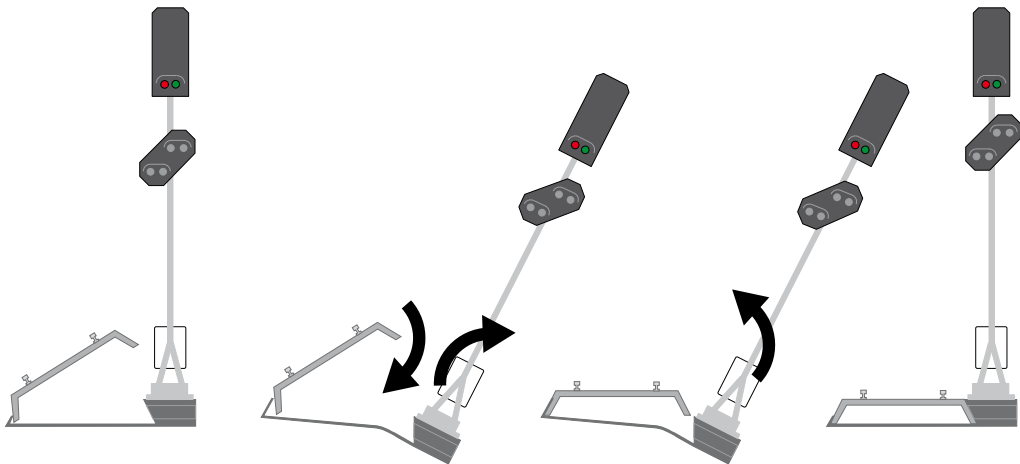

## Märklin C-Gleis

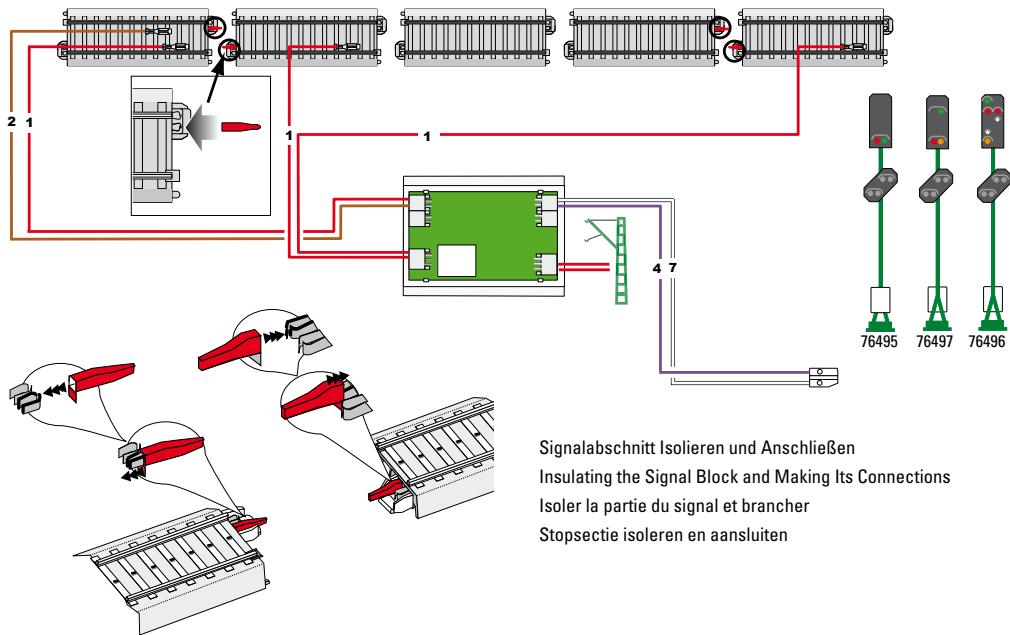

## Trix C-Gleis

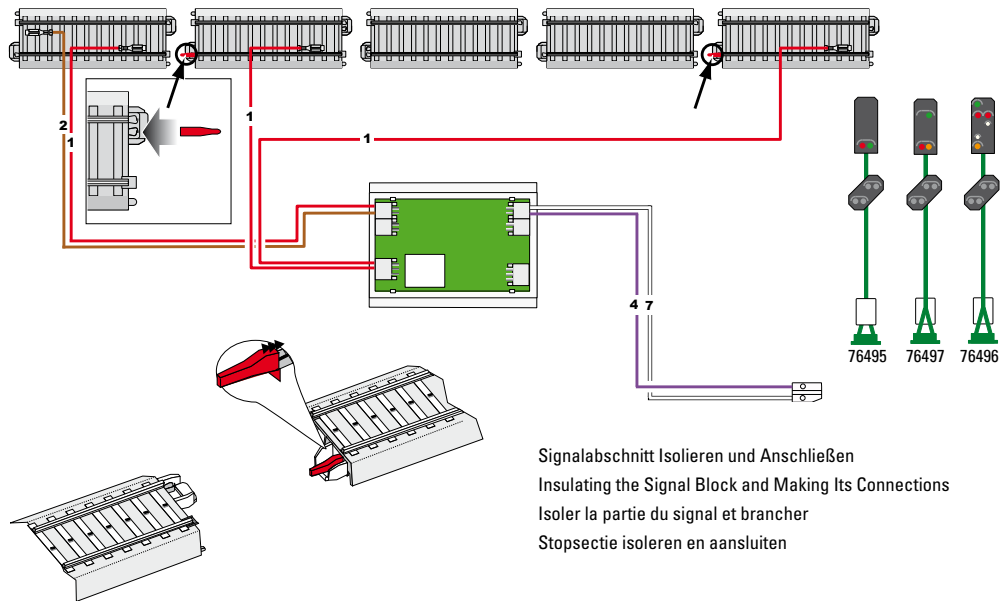

Montage auf K-Gleis Fundament • Slide the mast onto the K Track base •  
Glisser le mât sur la plaque de voie K • Mast op de K-rail plaat schuiven

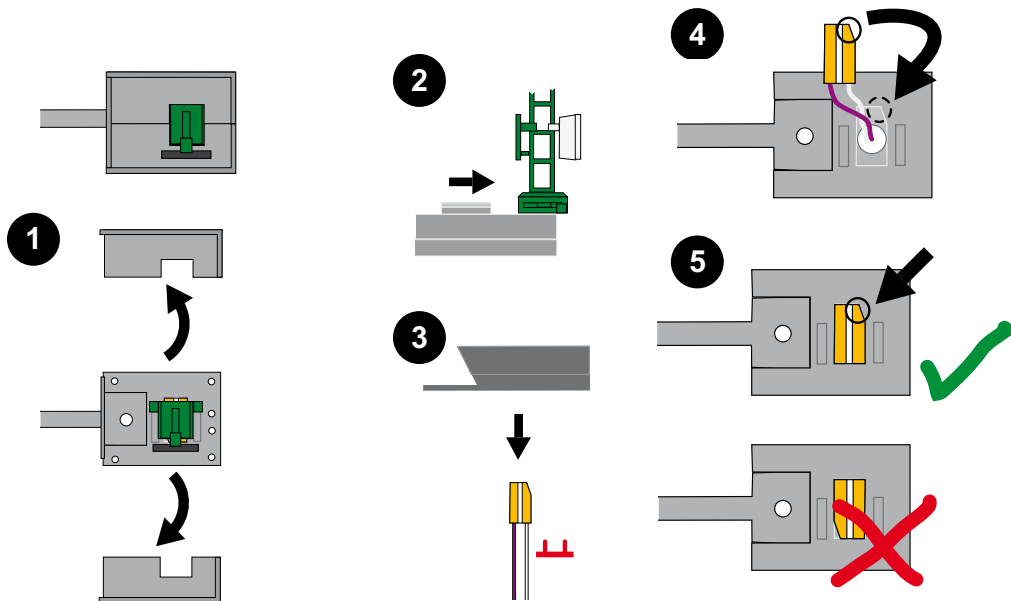

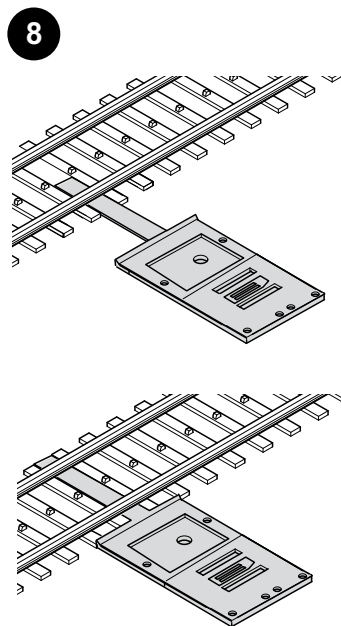
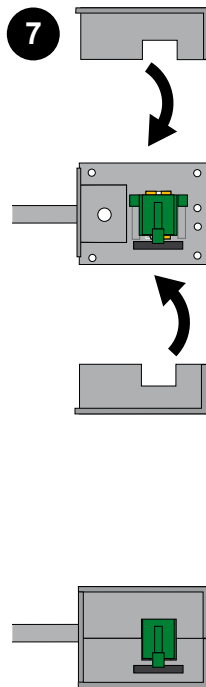
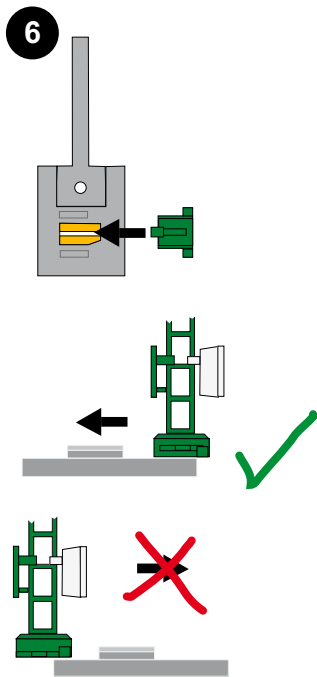

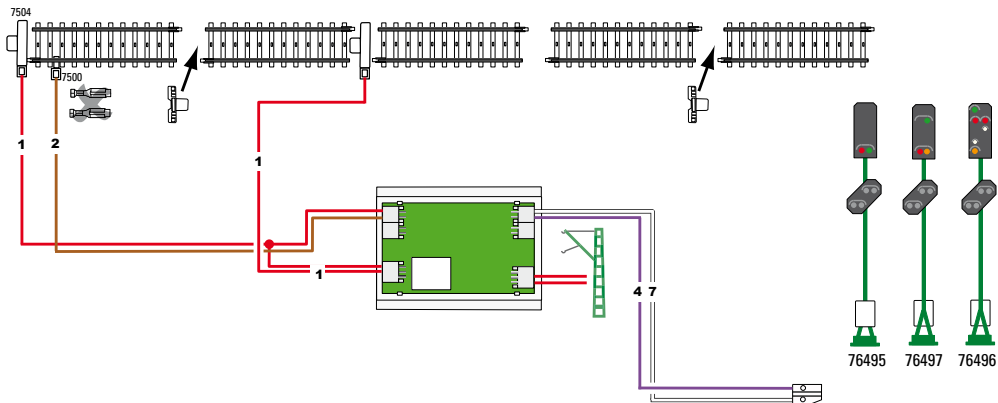

Signalabschnitt isolieren und anschließen; zusätzlich benötigen Sie 1x 7504 u. 1x 7500  
 Isolate and connect the signal block; additional materials required 1 x 7504 and 1 x 7500  
 Isolez et raccordez la section du signal ; il vous faut en outre 1x 7504 u. 1x 7500  
 Stopsectie isoleren en aansluiten; daarnaast heeft u 1 x 7504 en 1x 7500 nodig



Anschluss Bremsmodul • Connections for the Braking Module • Branchement module de freinage  
 Ansluiten afremmodule

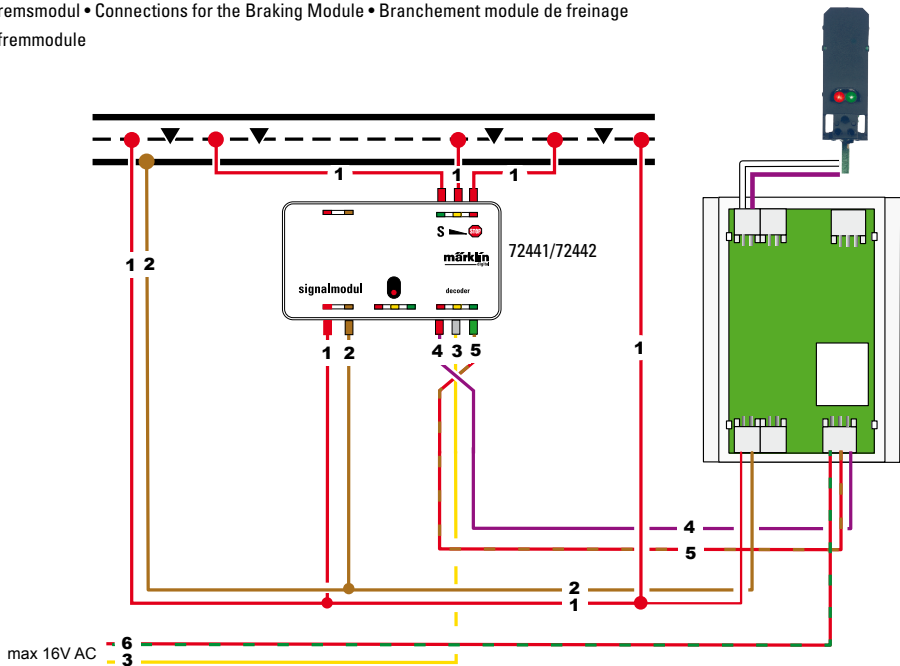

Steigung oder Gefälle beim Signalmast ausgleichen (3 % oder 5 %)

Level out an Ascending or Descending Grade at a Signal Mast (3% or 5%)

Equilibrage de la pente près d'un mât de signal (3 % ou 5 %)

Bij stijging of daling de mast bijstellen (3 % of 5 %)

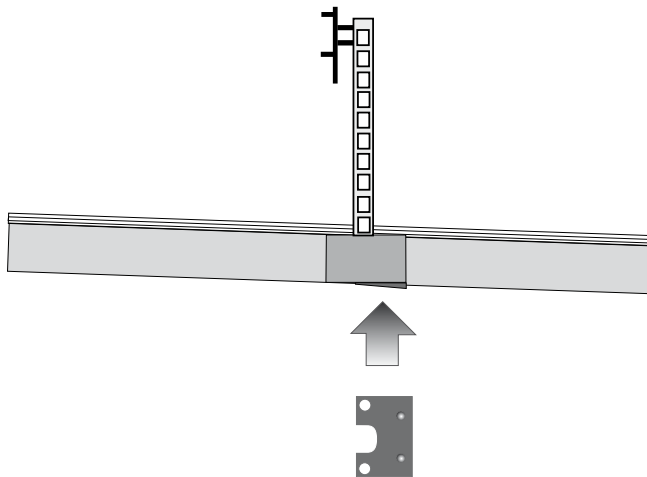

## Aufkleber anbringen • Attach decals • Fixez les autocollants • Bevestig stickers

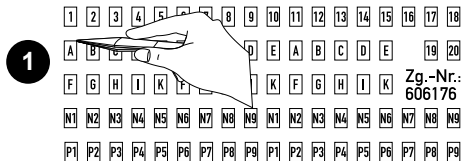

**2**



**3**

Due to different legal requirements regarding electro-magnetic compatibility, this item may be used in the USA only after separate certification for FCC compliance and an adjustment if necessary.

Use in the USA without this certification is not permitted and absolves us of any liability. If you should want such certification to be done, please contact us – also due to the additional costs incurred for this.

Gebr. Märklin & Cie. GmbH  
Stuttgarter Straße 55 - 57  
73033 Göppingen  
Germany  
[www.maerklin.com](http://www.maerklin.com)



[www.maerklin.com/en/imprint.html](http://www.maerklin.com/en/imprint.html)

243413/0415/Ha2Pw  
Änderungen vorbehalten  
© Gebr. Märklin & Cie. GmbH