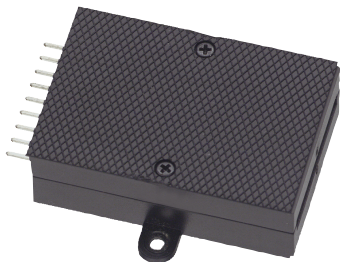

# märklin

---

**1**

**Digital-Decoder**

**Digital Decoder**

**Décodeur numérique à installer**

**Inbouw-digitaaldecoder**

**Decoder digital integrable**

**Decoder Digital installabile**

---

**59080**

<b>Inhaltsverzeichnis</b>	<b>Seite</b>	<b>Sommaire</b>	<b>Page</b>
Bestimmungsgemäße Verwendung	4	Usage conforme	10
Lieferumfang	4	Matériel fourni	10
Sicherheitshinweise	4	Consignes de sécurité	10
Wichtige Hinweise	4	Indications importantes	10
Funktionen	4	Fonctions	10
Decoder-Einbau	5	Installation du décodeur	11
Entsorgung	5	Elimination	11
Garantie	5	Garantie	11
CV Programmierung	6	Programmation des CV	12
Programmier-Tabellen	24	Tableau de programmation	24

<b>Table of Contents</b>	<b>Page</b>	<b>Inhoudsopgave</b>	<b>Pagina</b>
Normal Use	7	Beoogd gebruik	13
Contents as Delivered	7	Leveringsomvang	13
Safety Notes	7	Veiligheidsvoorschriften	13
Important Information	7	Belangrijke aanwijzingen	13
Functions	7	Werking	13
Decoder Installation	8	Decoder inbouwen	14
Disposal	8	Afdanken	14
Warranty	8	Garantie	14
CV Programming	9	CV-programmering	15
Programming Table	24	Programmeertabel	24

<b>Índice</b>	<b>Página</b>
Uso previsto	16
Alcance de suministro	16
Instrucciones de seguridad	16
Notas importantes	16
Funciones	16
Montaje del decoder	17
Eliminación	17
Garantía	17
Programación de variables CV	18
Tabla de programación	24

<b>Elenco del contenuto</b>	<b>Pagina</b>
Impiego commisurato alla destinazione	19
Corredo di fornitura	19
Avvertenze di sicurezza	19
Avvertenze importanti	19
Funzioni	19
Montaggio del Decoder	20
Smaltimento	20
Garanzia	20
Programmazione delle CV	21
Tabella di programmazione	24

## Bestimmungsgemäße Verwendung

- Der Einbau-Digital-Decoder ist zum Einbau in Märklin Spur 1-Weichen mit Weichenantrieb 59079 bestimmt.
- Darf nur in trockenen Räumen verwendet werden.

### Lieferumfang

Decoder  
2 Schrauben  
Einbauanleitung  
Garantiekunde

Für den Einbau zusätzlich benötigtes Werkzeug: Pinzette und Lötstation für eine Löttemperatur bis max. 30W/300° mit dünner Spitze, Elektronik-Lötzinn (Ø 0,5-1 mm), Entlötlitze oder Entlötaugpumpe.

## Sicherheitshinweise

- **ACHTUNG!** Funktionsbedingte scharfe Kanten und Spitzen.
- Verkabelungs- und Montagearbeiten nur im spannungslosen Zustand ausführen. Bei Nichtbeachtung kann es zu gefährlichen Körperströmen und damit zu Verletzungen führen.
- **Decoder nur mit der zulässigen Spannung** (siehe technische Daten) **betreiben.**



Beim Umgang mit dem Lötkolben besteht die Gefahr von **Hautverbrennungen.**

## Wichtige Hinweise

- **Achtung:** Beim Einbau möglichst keine Bauteile auf der Oberseite des Einbau-Digital-Decoders berühren, statische Aufladung kann die Funktion beeinträchtigen.
- Die Bedienungsanleitung ist Bestandteil des Produktes und muss deshalb aufbewahrt sowie bei Weitergabe des Produktes mitgegeben werden.

- Für Reparaturen wenden Sie sich bitte an Ihren Märklin-Fachhändler.
- <http://www.maerklin.com/en/imprint.html>

## Technische Daten

- |                              |                |
|------------------------------|----------------|
| • Belastung Weichenausgang   | max. 300 mA    |
| • Spannung Digitalstromkreis | max. 20 V eff. |
| • Spannungsfestigkeit        | max. 40 V      |

## Funktionen

- Multiprotokoll fähig: fx (MM) und DCC
- Einstellen der Betriebsart mittels DIP-Schalter
- Einstellbare Adressen mit DIP-Schalter:  
**1-256** fx (MM) (Control Unit 6021/Mobile Station 60651/652)  
**1-320** fx (MM) (Central Station 6021x/Mobile Station 60653)  
**1-511** (DCC)
- Programmierbare Adressen über CV → 
- **1-2044** DCC
- Änderungen der Eigenschaften über CV
- Stromversorgung über Digitalstromkreis

## Decoder-Einbau

Änderungen der Eigenschaften im fx (MM)-Protokoll durch CV Programmierung oder zur DCC CV-Programmierung folgen Sie dem Kapitel „CV Programmierung.“

**Folgende Arbeitsschritte dürfen nur im spannungslosen Zustand ausgeführt werden:**

**Beachten Sie**, dass Einstellungen mit dem DIP-Schalter immer spannungslos vorzunehmen sind. Der Einbau-Digital-Decoder erkennt erst mit dem Einschalten der Spannung die aktuellen Schalterstellungen.

Ab Seite 24 finden Sie die Tabelle für die Adressierung mit DIP-Schalter.

Einbau des Einbau-Digital-Decoders in Märklin-Weiche siehe Seite 22.

## Entsorgung

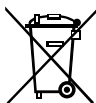

Hinweise zum Umweltschutz: Produkte, die mit dem durchgestrichenen Mülleimer gekennzeichnet sind, dürfen am Ende ihrer Lebensdauer nicht über den normalen Haushaltsmüll entsorgt werden, sondern müssen an einem Sammelpunkt für das Recycling von elektrischen und elektronischen Geräten abgegeben werden. Das Symbol auf dem Produkt, der Bedienungsanleitung oder der Verpackung weist darauf hin. Die Werkstoffe sind gemäß ihrer Kennzeichnung wiederverwertbar. Mit der Wiederverwendung, der stofflichen Verwertung oder anderen Formen der Verwertung von Altgeräten leisten Sie einen wichtigen Beitrag zum Schutze unserer Umwelt. Bitte erfragen Sie bei Ihrer Gemeindeverwaltung die zuständige Entsorgungsstelle.

## Garantie

Gewährleistung und Garantie gemäß der beiliegenden Garantieurkunde.

- Für Reparaturen wenden Sie sich bitte an Ihren Märklin-Fachhändler oder an  
Gebr. Märklin & Cie. GmbH  
Reparaturservice  
Stuttgarter Str. 55 - 57  
73033 Göppingen  
Germany  
Tel: 07161 608 222  
E-Mail: Service@maerklin.de

## CV Programmierung

Die CV Programmierung muss am Programmiergleis erfolgen. Für die Programmierung empfehlen wir, eine fiktive Lokomotive anzulegen. Werte in Klammern sind die Werkseinstellungen.

Während der Datenübertragung blinkt zur Kontrolle die am Einbau-Digital-Decoder angeschlossene Weichenlaternen.

### fx (MM)

Vor der Programmierung muss die zu programmierende Weiche mit dem Keyboard geschaltet werden. Danach unverzüglich mit der Control Unit bzw. CV Konfiguration der Central Station die CV geändert werden. Danach sofort die programmierte Weiche wieder mit dem Keyboard schalten. Erst jetzt ist die Programmierung übernommen und wirksam.

CV	Bedeutung	Werte	
8	Decoder-Reset	8 (-)	Werkseinstellung, Wert wird nicht geschrieben
37	Stellweg umkehren	0-1 (0)	Ändert die Schaltrichtung

Die Vorgehensweise beim Programmieren mit der Control Unit 6021 entspricht der Lokprogrammierung ([www.maerklin.de](http://www.maerklin.de) -> Service -> Technische Informationen).

## DCC

CV	Bedeutung	Werte	
1	Adresse, niederwertige Byte	0-255 (1)	
7	Hersteller Versionsnummer (Softwareversion)	(-)	nur lesen
8	Hersteller Kennung ID Decoder Reset	(131) 8 (-)	nur lesen, Werkseinstellung, Wert wird nicht geschrieben
9	Adresse, höherwertige Byte	0-7 (0)	
29	Konfiguration	(192)	nur lesen
	Bit 0-4 werden nicht verwendet	0	
	Bit 5: Decodertyp	0 / 32	Basis- o. erweiterter Zubehördecoder
	Bit 6: Adressierungsmethode	0 / 64	Decoder- o. Ausgangsadresse
	Bit 7: Decoderart	128	Zubehördecoder
37	Stellweg umkehren	0-1 (0)	Ändert die Schaltrichtung

### Einstellen und errechnen der Adressen größer 255:

Z.B. Adresse 1044 ->  $1044:256=4,078125$ . Der Wert vor dem Komma (4) ist in CV 9 einzutragen. Den Wert nach dem Komma (0,078125) wird mit 256 multipliziert  $0,078125 \times 256=20$ . Der errechnete Wert 20 muss in CV 1 eingetragen werden.

## Normal Use

- This digital installation decoder is designed for installation in Märklin 1 Track turnouts with a turnout mechanism 59079.
- This decoder may only be used in dry areas indoors.

### Contents as Delivered

1 digital installation decoder  
2 screw  
Installation instructions  
Warranty card

Additional tools required for installation: tweezers and soldering station for a maximum soldering temperature of 30 watts / 300° Celsius / 572° Fahrenheit with a fine point, Electronic solder (0.5-1 mm dia.), desoldering braid or desoldering pump.

## Safety Notes

- **IMPORTANT!** This product has sharp edges and points related to its function.
- Do wiring and assembly work only in a voltage-free work environment. Otherwise you may experience electrical current dangerous to the body leading to injury.
- **Operate this decoder only with the permissible voltage** (see technical information).



When using a solder station there is the danger of **burning your skin.**

## Important Information

- **Important:** When installing the digital installation decoder, try to avoid touching components on the upper side of the decoder. Static charge can affect the function of the decoder.
- The operating instructions are a component part of the product and must therefore be kept with the product,

particularly when it is given to another party.

- For repairs please see your authorized Märklin specialty dealer.
- <http://www.maerklin.com/en/imprint.html>

## Technical Data

- Load at turnout output max. 300 amps
- Voltage for the digital power circuit max. 20 volts eff.
- Electrical strength max. 40 volts

## Functions

- Capable of multi-protocols: fx (MM) and DCC
- Mode of operation set with DIP switches
- Addresses can be set with DIP switches:  
**1-256** fx (MM) (Control Unit 6021/Mobile Station 60651/652)  
**1-320** fx (MM) (Central Station 6021x/Mobile Station 60653)  
**1-511** (DCC)
- Programmable addresses using CVs →   
**1-2044** DCC
- Changes to characteristics can be done with CVs
- Power supply done using the digital power circuit

## Decoder Installation

See the section “CV Programming” for changes to other characteristics in the fx (MM) protocol using CV programming or to the DCC CV programming.

### The following work steps may only be done in a voltage-free work environment:

**Note:** Settings with the DIP switches are to be only when the voltage is turned off. The digital installation decoder does not recognize the current switch settings until the voltage is turned on.

Starting on page 24 you'll find the table for setting addresses with DIP switches.

See page 22 for installation of the digital installation decoder in Märklin standard turnouts, curved turnouts, or double slip switches.

## Disposal



Information about protecting the environment: Products marked with a trashcan with a line through it may not be disposed of at the end of their useful life along with the normal household trash. They must be taken to a collection point for recycling electrical and electronic devices. The symbol on the product, the instructions, or the packaging indicates this. Depending on their description, the raw materials can be used again. You make an important contribution to the protection of our environment with the recycling of this material from old devices. Please inquire in your community about the appropriate disposal site.

## Warranty

The warranty terms are stated on the warranty card included with this product.

- Please see your authorized Märklin specialty dealer or  
Gebr. Märklin & Cie. GmbH  
Reparaturservice  
Stuttgarter Str. 55 - 57  
73033 Göppingen  
Germany  
Tel: +49 7161 608 222  
E-mail: [Service@maerklin.de](mailto:Service@maerklin.de)



## CV Programming

CV programming must be done on the programming track. We recommend creating a fictitious locomotive for programming purposes. Values in parentheses are the factory settings.

The turnout lantern connected to the digital installation decoder will blink as a control check during the data transmission.

### fx (MM)

Before doing any programming, the turnout to be programmed must be switched with the Keyboard. After that the CVs are changed immediately with the Control Unit or the CV configuration on the Central Station. After that the programmed turnout is to be switched again with the Keyboard. At this point the programming is accepted and is functional.

CV	Meaning	Values	
8	Decoder reset	8 (-)	factory setting, not written value is
37	Reverse travel range	0-1 (0)	Changes the electrical switching direction

The procedure for programming with the 6021 Control Unit is the same as locomotive programming ([www.maerklin.de](http://www.maerklin.de) -> Service -> Technische Informationen).

## DCC

CV	Meaning	Values	
1	Address, lower value Byte	0-255 (1)	
7	Manufacturer version number (software version)	(-)	read only
8	Manufacture recognition ID Decoder reset	(131) 8 (-)	read only, factory setting, value is not written
9	Address, higher value Byte	0-7 (0)	
29	Configuration	(192)	read only
	Bits 0-4 are not used	0	
	Bit 5: Decoder type	0 / 32	basic or advanced accessory decoder
	Bit 6: Addressing method	0 / 64	decoder or output address
	Bit 7: Decoder type	128	accessory decoder
37	Reverse travel range	0-1 (0)	Changes the electrical switching direction

### Setting and generating addresses larger than 255:

Example: Address 1044 -> 1044:256=4,078125. The value before the comma (4) is to be entered in CV 9. The value after the comma (0,078125) is multiplied by 256, 078125x256=20. The value of 20 that is generated must be entered in CV 1.

## Usage conforme

- Le décodeur numérique est conçu pour être installé dans des aiguilles de voie 1 Märklin équipées d'un moteur 59079.
- A utiliser exclusivement dans des pièces sèches.

### Matériel fourni

1 Décodeur numérique à installer

2 vis

Notice d'installation

Bon de garantie

Outils nécessaires à l'installation : Pincette et poste à souder pour une température de brasage maximale de 30 W/300° avec pointe fine, fil à souder pour électronique (Ø 0,5-1 mm), tresse à dessouder ou pompe à dessouder.

## Consignes de sécurité

- **ATTENTION !** L'appareil présente des arêtes coupantes.
- Câblage et montage doivent être réalisés uniquement quand l'appareil est hors tension. Le non respect de ces consignes peut générer des courants de choc dangereux et être à l'origine de blessures.
- **Exploiter le décodeur uniquement avec la tension autorisée** (voir caractéristiques techniques).



Risques de **brûlures** lors de la manipulation du fer à souder.

## Indications importantes

- **Attention :** Lors de l'installation, éviter dans la mesure du possible de toucher les composants situés sur la face supérieure du décodeur numérique, une charge statique pouvant entraver le fonctionnement.
- La notice d'utilisation fait partie intégrante du produit ; elle doit donc être conservée et, le cas échéant, transmise avec le produit.
- Pour toute réparation, adressez-vous SVP à votre détaillant spécialisé Märklin.
- <http://www.maerklin.com/en/imprint.html>

## Caractéristiques techniques

- Charge sortie aiguille max. 300 mA
- Tension circuit numérique max. 20 V eff.
- Tenue en tension max. 40 V

## Fonctions

- multi protocole: fx (MM) et DCC
- Définition du mode d'exploitation via commutateur DIP
- Définition des adresses possible via commutateur DIP :  
**1-256** fx (MM) (Control Unit 6021/Mobile Station 60651/652)  
**1-320** fx (MM) (Central Station 6021x/Mobile Station 60653)  
**1-511** (DCC)
- Adresses programmables via CV → 
- **1-2044** DCC
- Modifications des propriétés via CV
- Alimentation en courant via circuit numérique

## Installation du décodeur

Pour modifier les autres caractéristiques dans le protocole fx (MM) via la programmation des CV ou pour la programmation des CV dans le protocole DCC, veuillez suivre les indications du chapitre « Programmation des CV ».

**L'installation, dont les différentes étapes sont décrites ci-dessous, doit impérativement être réalisée hors tension :**

**Attention :** Les paramétrages avec le commutateur DIP doivent toujours se faire hors tension. Le décodeur numérique ne reconnaît les nouvelles positions du commutateur qu'à la mise sous tension.

Vous trouverez le tableau pour la définition des adresses avec commutateur DIP à partir de la page 24.

Installation du décodeur numérique dans les aiguillages Märklin : voir page 22.

## Elimination



Indications relatives à la protection de l'environnement : Les produits marqués du signe représentant une poubelle barrée ne peuvent être éliminés en fin de vie via les ordures ménagères normales, mais doivent être remis à un centre de collecte pour le recyclage des appareils électriques et électroniques. Le symbole figurant sur le produit lui-même, la notice d'utilisation ou l'emballage l'indique. Les matériaux sont recyclables selon leur marquage. Avec le recyclage, la récupération des matériaux ou autres formes de valorisation de vieux appareils, vous contribuez sensiblement à la protection de notre environnement. Renseignez-vous auprès de votre municipalité sur les centres compétents pour le traitement des déchets.

## Garantie

Garantie légale et garantie contractuelle conformément au bon de garantie ci-joint.

- Pour toute réparation, veuillez vous adresser à votre détaillant spécialisé Märklin ou à  
Gebr. Märklin & Cie. GmbH  
Reparaturservice  
Stuttgarter Str. 55-57  
73033 Göppingen  
Germany  
Tél. : +49 7161 608 222  
e-mail : Service@maerklin.de

## Programmation des CV

La programmation des CV se fait sur la voie de programmation. Pour la programmation, nous vous conseillons de créer une locomotive fictive. Les valeurs indiquées entre parenthèses correspondent aux paramètres d'usine.

Durant la transmission des données, la lanterne d'aiguille raccordée au décodeur numérique clignote (contrôle).

### fx (MM)

Avant de procéder à la programmation, commutez l'aiguille à programmer via le Keyboard. Modifiez ensuite sans attendre la CV avec la Control Unit, respectivement via la fonction de configuration des CV de la Central Station. Commutez alors à nouveau et immédiatement l'aiguille programmée via le Keyboard. La programmation est enfin enregistrée et effective.

CV	Signification	Valeurs	
8	Réinitialisation du décodeur	8 (-)	Paramètre d'usine, la valeur n'est pas enregistrée
37	Inverser la course de manoeuvre	0-1 (0)	Modifie le sens de commutation

La procédure à suivre pour la programmation avec la Central Unit 6021 correspond à la programmation de la loco ([www.maerklin.de](http://www.maerklin.de) -> Service -> Technische Informationen).

## DCC

CV	Signification	Valeurs	
1	Adresse, octet de valeur basse	0-255 (1)	
7	Numéro de version fabricant (version logicielle)	(-)	Lire uniquement
8	Identifiant du fabricant Réinitialisation du décodeur	(131) 8 (-)	Lire uniquement, paramètre d'usine, la valeur n'est pas enregistrée
9	Adresse, octet de valeur supérieure	0-7 (0)	
29	Configuration	(192)	Lire uniquement
	Bits 0 à 4 non utilisés	0	
	Bit 5: Type de décodeur	0 / 32	Décodeur d'accessoires de base ou avancé
	Bit 6: Méthode d'adressage	0 / 64	Adresse du décodeur ou adresse de départ
	Bit 7: Type de décodeur	128	Décodeur d'accessoires
37	Inverser la course de manoeuvre	0-1 (0)	Modifie le sens de commutation

### Définition et calcul des adresses supérieures à 255 :

Par ex. Adresse 1044 ->  $1044:256=4,078125$ . La valeur avant la virgule (4) est à reporter dans la CV 9. La valeur située après la virgule (0,078125) est multipliée par 256  $0,078125 \times 256=20$ . La valeur calculée 20 est à reporter dans la CV 1.

## Beoogd gebruik

- De inbouw-digitaaldecoder is bedoeld voor het inbouwen in Märklin- 1-rail wissels met wisselaandrijving 59079.
- Mag alleen in droge ruimtes gebruikt worden.

### Leveringsomvang

1 inbouw-digitaaldecoder  
2 schroef  
Gebruiksaanwijzing  
Garantiebewijs

Voor het inbouwen is het volgende gereedschap nodig: pincet en soldeerstation met een maximale temperatuur van 30 W/300° C met een dunne stift, elektronica soldeertin (0.5 - 1mm), desoldeertin of soldeertinzuiger.

## Veiligheidsvoorschriften

- **Let op!** bevat vanwege zijn functie scherpe randen en punten.
- Bedrading- en montage alleen in spanningloze toestand uitvoeren. Bij het niet naleven kunnen er gevaarlijke stromen door het lichaam vloeien en verwondingen ontstaan.
- **Decoder alleen met de toegelaten spanning** (zie technische gegevens) **gebruiken**.



Bij het werken met een soldeerbout bestaat het gevaar voor **brandwonden**.

## Belangrijke aanwijzingen

- **Let op:** bij het inbouwen de delen op de bovenzijde van de inbouw-digitaaldecoder niet aanraken, statische ontlading kan de juiste werking beïnvloeden.
- De gebruiksaanwijzing is onderdeel van het product en moet derhalve bij de overdracht van het product meegegeven worden.
- Voor reparaties kunt u zich tot uw Märklin dealer wenden.
- <http://www.maerklin.com/en/imprint.html>

## Technische gegevens

- Belasting wisseluitgang max. 300 mA
- Spanning digitale stroomkring max. 20 V eff.
- Diëlektrische sterkte max. 40 V

## Werking

- Multiprotocol: fx (MM) en DCC
- Instellen van het bedrijfssysteem met DIP-schakelaar
- Instellen van het adres met DIP-schakelaar  
**1-256 fx (MM)** (Control Unit 6021/Mobile Station 60651/652)  
**1-320 fx (MM)** (Central Station 6021x/Mobile Station 60653)  
**1-511 (DCC)**
- Programmeerbare adressen via CV → 
- **1-2044 DCC**
- Wijzigen van de eigenschappen via CV
- Stroomvoorziening via digitale stroomkring

## Decoder inbouwen

Veranderen van de te wijzigende eigenschappen in het fx (MM) protocol door CV programmering of het DCC CV programmering vindt u in het hoofdstuk "CV programmering".

### **De volgende stappen mogen alleen in spanningloze toestand uitgevoerd worden:**

**Let op:** instellingen van de DIP-schakelaars alleen in spanningloze toestand uitvoeren. De inbouw-digitaaldecoder herkent de actuele schakelaarstand pas na het inschakelen van de voedingsspanning.

Vanaf pagina 24 vindt u de tabel voor de adressering met de DIP-schakelaars.

Inbouw van de inbouw-digitaaldecoder in de Märklin standaard-meegebogen- en kruiswissels zie pagina 22.

## Afdanken

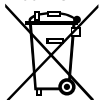

Milieu-informatie: producten, die met de doorgestreepte afvalcontainer zijn gemarkeerd, mogen aan het einde van hun levensduur niet met het normale huisvuil meegegeven worden, maar moeten op een verzamelpunt voor de recycling van elektrische en elektronische apparatuur afgegeven worden. Het symbool op het product, op de handleiding of op de verpakking geeft dit aan. De materialen worden gerecycled in overeenstemming met hun identificatie. Met het hergebruik van de grondstoffen of andere vormen van het hergebruik van oude apparatuur levert u een belangrijke bijdrage aan de bescherming van ons milieu. Neem contact op met uw gemeente voor een bevoegde plaatselijke inzamelplaats.

## Garantie

Waarborg en garantie volgens bijgevoegd garantiebewijs.

- Voor reparaties kunt u zich wenden tot uw Märklin dealer of tot  
Gebr. Märklin & Cie. GmbH  
Reparaturservice  
Stuttgarter Str. 55 - 57  
73033 Göppingen  
Germany  
Tel: +49 7161 608 222  
E-Mail: Service@maerklin.de

## CV Programmering

De CV programmering moet via het programmeerspoor gebeuren. Voor het programmeren is het aan te bevelen een fictive loc aan te maken. De waarden tussen haakjes zijn de af fabriek ingestelde waarden.

Tijdens de dataoverdracht knippert, ter controle, de aan de inbouw-digitaaldecoder aangesloten wisselantaarn.

### fx (MM)

Voor het programmeren moet de te programmeren wissel met het keyboard geschakeld worden. Daarna onmiddellijk met de Control Unit resp. via CV configuratie met het Central Station de CV wijzigen. Daarna direct de geprogrammeerde wissel met het keyboard schakelen. Pas dan is de programmering overgenomen en werkzaam.

CV	Omschrijving	Waarde	
8	Decoder reset	8 (-)	Fabrieksinstelling, waarde wordt niet geschreven
37	Stelrichting omkeren	0-1 (0)	Wijzigt de schakelrichting

De werkwijze bij het programmeren met de Control Unit 6021 komt overeen met het programmeren van een locomotief-decoder ([www.maerklin.de](http://www.maerklin.de) -> Service -> Technische Informatie).

## DCC

CV	Omschrijving	Waarde	
1	Adres, lage byte	0-255 (1)	
7	Fabrikant versienummer (softwareversie)	(-)	alleen lezen
8	Fabrikant kenmerk ID decoder reset	(131) 8 (-)	alleen lezen, fabrieksinstelling, waarde wordt niet geschreven
9	Adres, hoge byte	0-7 (0)	
29	Configuratie	(192)	alleen lezen
	Bit 0-4 worden niet gebruikt	0	
	Bit 5: decodertype	0 / 32	Basis- of uitgebreide toebehoren decoder
	Bit 6: adresseringsmethode	0 / 64	Decoder of uitgangs-adres
	Bit 7: decodertype	128	Toebehoren decoder
37	Stelrichting omkeren	0-1 (0)	Wijzigt de schakelrichting

### Instellen en berekenen van de adressen groter dan 255:

Bijv. adres 1044 ->  $1044:256=4,078125$ . De waarde voor de komma (4) moet in CV 9 ingevoerd worden. De waarde achter de komma (0,078125) wordt nu met 256 vermenigvuldigd  $0,078125 \times 256=20$ . De berekende waarde 20 moet in CV 1 ingevoerd worden.

## Uso previsto

- El decoder digital integrable está destinado para el montaje en desvíos para vías 1 de Märklin con accionamiento de aguja 59079.
- Su uso está permitido únicamente en recintos secos.

### Alcance de suministro

1 decoder digital integrable  
2 tornillo  
Instrucciones de montaje  
Documento de garantía

Herramienta adicional necesaria para el montaje: Pinza y estación de soldadura para una temperatura de soldeo de máx. 30W/300° con punta fina, estaño de soldar para electrónica (Ø 0,5-1 mm), cordón de desoldeo o bomba aspiradora de desoldeo.

## Instrucciones de seguridad

- **¡ATENCIÓN!** El diseño presenta aristas y puntas cortantes impuestas por las características funcionales.
- Ejecutar los trabajos de cableado y montaje únicamente sin tensión. En el caso de inobservancia pueden producirse corrientes peligrosas a través del cuerpo y, por tanto, lesiones.
- **Utilizar el decoder únicamente con la tensión admisible** (véase Datos técnicos).  
 Al manejar el soldador pueden producirse **quemaduras de la piel.**

## Notas importantes

- **Atención:** En el montaje, a ser posible, no tocar componentes situados en el lado superior del decoder digital integrable ya que las cargas estáticas pueden perjudicar a su funcionamiento.
- Las instrucciones de empleo forman parte integrante del producto y, por este motivo, deben conservarse y entregarse al nuevo comprador en el caso de venta del mismo.
- Para reparaciones, por favor diríjase a su distribuidor especializado de Märklin.
- <http://www.maerklin.com/en/imprint.html>

## Datos técnicos

- |                               |                |
|-------------------------------|----------------|
| • Carga por salida de desvío  | max. 300 mA    |
| • Tensión de circuito digital | máx. 20 V efi. |
| • Rigidez dieléctrica         | máx. 40 V      |

## Funciones

- Apto para múltiples protocolos: fx (MM) y DCC
- Configuración del modo mediante microinterruptor DIP
- Direcciones configurables mediante interruptor DIP:  
**1-256** fx (MM) (Control Unit 6021/Mobile Station 60651/652)  
**1-320** fx (MM) (Central Station 6021x/Mobile Station 60653)  
**1-511** (DCC)
- Direcciones programables mediante variables CV →  
 → **1-2044** DCC
- Modificación de las características mediante variables CV
- Alimentación eléctrica mediante circuito digital



## Montaje del decoder

En el capítulo “Programación de las CVs” se explican las modificaciones de las demás características en el protocolo fx (MM) mediante programaciones de variables CV o para la programación de variables CV en el protocolo DCC.

**Está permitido ejecutar las siguientes operaciones únicamente sin tensión.**

**Nota importante:** Realizar los ajustes con el microinterruptor DIP siempre sin tensión. El decoder digital integrable no reconoce las posiciones actuales de los microinterruptores hasta que no se enciende la alimentación eléctrica.

A partir de la página 24 encontrará la tabla para el direccionamiento con microinterruptores DIP.

Para el montaje del decoder digital integrable en un desvío estándar, un desvío en curvas o una travesía de unión doble de Märklin, véase Página 22.

## Eliminación



Instrucciones para protección del medio ambiente: Los productos identificados con el cubo de basura tachado no deben eliminarse junto con la basura doméstica normal y corriente una vez alcanzado el final de su vida útil, sino que deben entregarse en un punto de recogida para el reciclaje de equipos eléctricos y electrónicos. El símbolo que aparece en el producto, en las instrucciones de empleo o en el embalaje hace referencia a ello. Los materiales son reutilizables conforme a su identificación. Con la reutilización, el aprovechamiento de los materiales u otras formas de reciclado de aparatos viejos hacemos una aportación importante a la protección del medio ambiente. Consulte en su Ayuntamiento cuál es la entidad de recogida competente.

## Garantía

La garantía legal y la garantía del fabricante se basan en el documento de garantía adjunto.

- Para reparaciones, diríjase a su distribuidor profesional de Märklin-  
o a  
Gebr. Märklin & Cie. GmbH  
Reparaturservice  
Stuttgarter Str. 55 - 57  
73033 Göppingen  
Germany  
Tel: +49 7161 608 222  
E-Mail: Service@maerklin.de

## Programación de variables CV

La programación de variables CV debe realizarse en la vía de programación. Para la programación recomendamos crear una locomotora ficticia. Los valores entre paréntesis representan la configuración de fábrica.

Durante la transmisión de datos, para comprobación, destella el farol de aguja conectado al decoder digital integrable.

### fx (MM)

Antes de la programación, debe conmutarse con el Keyboard el desvío que se desee programar. Inmediatamente después debe modificarse la CV con la Control Unit o bien con la función Configuración de CV de la Central Station. A continuación, conmutar de nuevo inmediatamente el desvío programado. Hasta que esto no se haya hecho no se aplicará ni tendrá efecto la programación.

CV	Significado	Valores	
8	Reset de decoder	8 (-)	Configuración de fábrica, no se escribe el valor
37	Invertir el recorrido de enclavamiento	0-1 (0)	Cambia el sentido de maniobra

El procedimiento en la programación con la Central Unit equivale a la programación de locomotora ([www.maerklin.de](http://www.maerklin.de) -> Service -> Technische Informationen).

## DCC

CV	Significado	Valores	
1	Dirección, byte de menor peso	0-255 (1)	
7	Número de versión de fabricante (versión de software)	(-)	Sólo lectura
8	ID ident. de fabricante Reset de decoder	(131) 8 (-)	Sólo lectura, configuración de fábrica, no se escribe el valor
9	Dirección, byte de mayor peso	0-7 (0)	
29	Configuración	(192)	Sólo lectura
	Bit 0-4 No se utilizan los bits	0	
	Bit 5: Modelo de decoder	0 / 32	Decoder accesorio básico o ampliado
	Bit 6: Método de direccionamiento	0 / 64	Dirección de decoder o inicial
	Bit 7: Tipo de decoder	128	Decoder accesorio
37	Invertir el recorrido de enclavamiento	0-1 (0)	Cambia el sentido de maniobra

### Configuración y cálculo de las direcciones mayores que 255:

P. ej., dirección 1044 ->  $1044:256=4,078125$ . El valor antes de la coma (4) debe registrarse en la CV 9. El valor después de la coma (0,078125) se multiplica por 256  $0,078125 \times 256=20$ . El valor calculado 20 debe registrarse en CV 1.

## Impiego commisurato alla destinazione

- Tale Decoder Digital installabile è destinato al montaggio nei deviatori del binario Märklin 1 con azionamento per deviatori 59079.
- Deve essere impiegato solamente in luoghi asciutti.

### Corredo di fornitura

- 1 Decoder Digital installabile
- 2 Vite
- Istruzioni di montaggio
- Certificato di garanzia

Attrezzi necessari in aggiunta per il montaggio: una pinzetta e una stazione di saldatura per una temperatura di saldatura sino a un max. di 30W/300° con una punta sottile, lega per saldature elettroniche (Ø 0,5-1 mm), trecciola dissaldante oppure pompetta aspirante per dissaldare.

## Avvertenze di sicurezza

- **ATTENZIONE!** Spigoli e punte affilati per necessità funzionale.
- Si eseguano i lavori di cablaggio e di montaggio solo in condizioni esenti da tensione. In caso di mancato rispetto questo può condurre a pericolose correnti nel corpo e di conseguenza a ferimenti.
- **Si faccia funzionare il Decoder solamente con la tensione ammissibile** (si vedano i dati tecnici).



Durante le operazioni con il saldatore sussiste il pericolo di **scottature della pelle**.

## Avvertenze importanti

- **Attenzione:** durante il montaggio si tocchino il meno possibile i componenti sul lato superiore del Decoder Digital installabile, le cariche statiche possono compromettere la funzionalità.
- Le istruzioni di impiego costituiscono parte integrante del prodotto e devono pertanto venire conservate con cura nonché consegnate insieme in caso di cessione a terzi del prodotto.
- Per riparazioni Vi preghiamo di rivolgerVi al Vostro rivenditore specialista Märklin.
- <http://www.maerklin.com/en/imprint.html>

## Dati tecnici

- Carico dell'uscita per deviatori max. 300 mA
- Tensione nel circuito di corrente Digital max. 20 V eff.
- Rigidità dielettrica max. 40 V

## Funzioni

- Capacità multi-protocollo: fx (MM) und DCC
- Impostazione del tipo di funzionamento a mezzo commutatori DIP
- Indirizzi impostabili con commutatori DIP:  
**1-256** fx (MM) (Control Unit 6021/Mobile Station 60651/652)  
**1-320** fx (MM) (Central Station 6021x/Mobile Station 60653)  
**1-511** (DCC)
- Indirizzi programmabili tramite CV → 
- **1-2044** DCC
- Modificazione delle caratteristiche tramite CV
- Segnale Digital: trasmissione indipendente dall'alimentazione di corrente
- Alimentazione di corrente tramite circuito di corrente Digital

## Montaggio del Decoder

Per modificazioni delle altre caratteristiche nel protocollo fx (MM) mediante programmazione delle CV oppure per programmazione delle CV in DCC seguite il capitolo «Programmazione delle CV.»

**I seguenti passaggi del lavoro devono essere eseguiti solamente in condizioni esenti da tensione.**

**Prestate attenzione:** si intraprendano le impostazioni con il commutatore DIP sempre senza tensione. Il Decoder Digital installabile riconosce le attuali disposizioni del commutatore solo con l'attivazione della tensione.

A partire da pagina 24 potete trovare la tabella per l'indirizzamento con il commutatore DIP.

Per il montaggio del Decoder Digital installabile in deviatore Märklin si veda a pagina 22.

## Smaltimento



Avvertenze per la salvaguardia ambientale: i prodotti che sono contraddistinti con la pattumiera cancellata, alla fine della loro durata di vita non devono venire smaltiti tramite i normali rifiuti domestici, bensì devono venire conferiti ad un punto di raccolta per il riciclo di apparecchi elettrici ed elettronici. Tale simbolo sul prodotto, sulle istruzioni di impiego oppure sulla confezione dà avviso di questo. I materiali sono nuovamente utilizzabili in conformità al loro simbolo di riconoscimento. Con il riutilizzo, la valorizzazione dei materiali oppure altre forme di recupero degli apparecchi vecchi Voi fornite un importante contributo alla salvaguardia del nostro ambiente. Vi preghiamo di chiedere presso la Vostra amministrazione municipale i punti di smaltimento autorizzati.

## Garanzia

Prestazioni di garanzia e garanzie in conformità all'accluso certificato di garanzia.

- Per riparazioni Vi preghiamo di rivolgerVi al Vostro rivenditore specialista Märklin oppure a  
Gebr. Märklin & Cie. GmbH  
Reparaturservice  
Stuttgarter Str. 55 - 57  
73033 Göppingen  
Germany  
Tel: +49 7161 608 222  
E-Mail: Service@maerklin.de

## Programmazione delle CV

La programmazione delle CV deve avvenire sul binario di programmazione. Per tale programmazione noi consigliamo di inserire una locomotiva immaginaria. I valori tra parentesi sono le impostazioni di fabbrica.

Durante la trasmissione dei dati lampeggia per controllo la lanterna da deviatoi collegata al Decoder Digital installabile.

### fx (MM)

Prima della programmazione il deviatoo da programmare deve venire commutato con la Keyboard. Dopo di ciò le CV vengono immediatamente modificate con la Control Unit o rispettivamente la configurazione CV della Central Station. Dopodiché si commuti subito nuovamente il deviatoo programmato con la Keyboard. Soltanto ora la programmazione è acquisita ed operativa.

CV	Significato	Valori	
8	Ripristino Decoder	8 (-)	Impostazioni di fabbrica, il valore non viene scritto
37	Inversione corsa di lavoro	0-1 (0)	Modifica la direzione di commutazione

Il modo operativo nella programmazione con la Central Unit 6021 corrisponde alla programmazione della locomotive ([www.maerklin.de](http://www.maerklin.de) -> Service -> Technische Informationen).

## DCC

CV	Significato	Valori	
1	Indirizzo, byte di valore più basso	0-255 (1)	
7	Numero di versione del fabbricante (Versione Software)	(-)	sola lettura
8	ID identificativo del fabbricante Ripristino Decoder	(131) 8 (-)	sola lettura, Impostazioni di fabbrica, il valore non viene scritto
9	Indirizzo, byte di valore più alto	0-7 (0)	
29	Configurazione	(192)	sola lettura
	I bit 0-4 non vengono usati	0	
	Bit 5: tipo di Decoder	0 / 32	Decoder per accessori di base o esteso
	Bit 6: metodo di indirizzamento	0 / 64	Indirizzo Decoder o di uscita
	Bit 7: tipo di Decoder	128	Decoder per accessori
37	Inversione corsa di lavoro	0-1 (0)	Modifica la direzione di commutazione

### Impostazione e calcolo degli indirizzi maggiori di 255:



Ad es. indirizzo 1044 -> 1044:256=4,078125 . Il valore prima della virgola (4) si deve inserire in CV 9. Il valore dopo la virgola (0,078125) viene moltiplicato per 256: 0,078125x256=20. Il valore calcolato 20 deve venire inserito in CV 1.

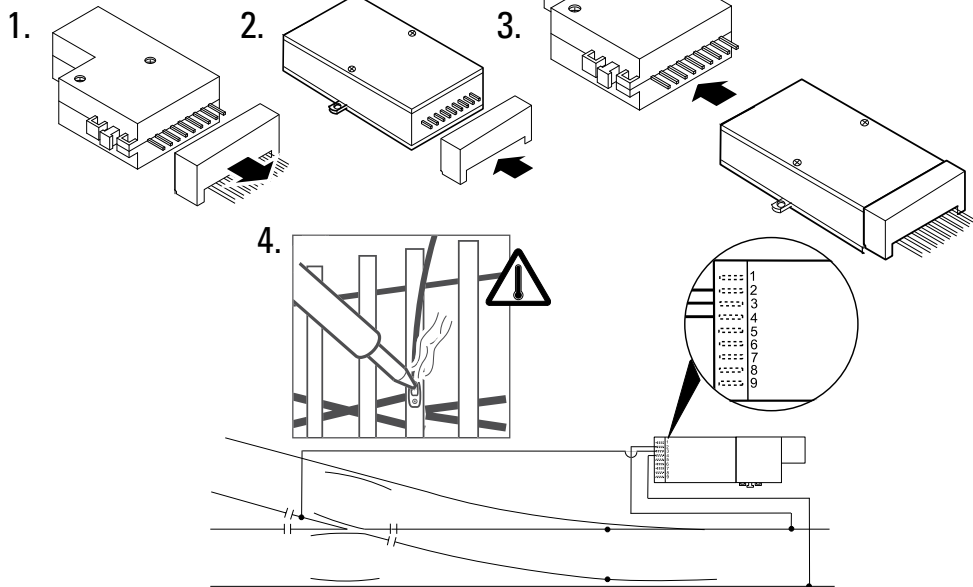

**Decoder-Einbau • Decoder Installation • Installation du decodeur •  
Decoder inbouwen • Montaje del decoder • Montaggio del Decoder •**

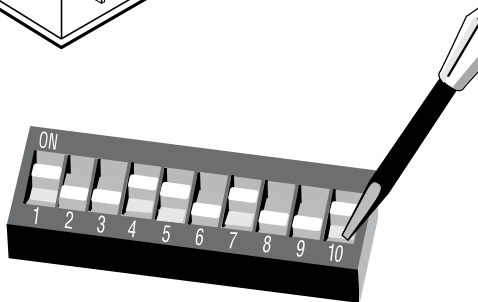
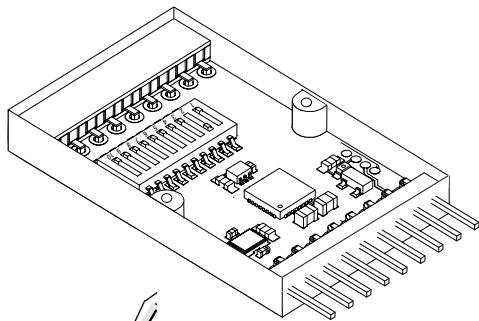
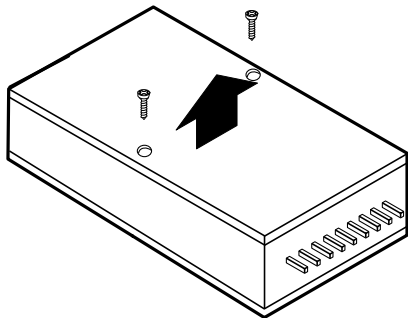



**Betriebsart und Adressen einstellen • Setting the mode of operation and addresses • Définir le mode d'exploitation et les adresses • Bedrijfsmodus en adres instellen • Configuración de modo de funcionamiento y direcciones • Impostare tipo di funzionamento e indirizzi**









				10 (0/1)	
1	1	1	1		fx (MM)/DCC
2	1	2	2		fx (MM)/DCC
3	1	3	1 2		fx (MM)/DCC
4	1	4	3		fx (MM)/DCC
5	1	5	1 3		fx (MM)/DCC
6	1	6	2 3		fx (MM)/DCC
7	1	7	1 2 3		fx (MM)/DCC
8	1	8	4		fx (MM)/DCC
9	1	9	1 4		fx (MM)/DCC
10	1	10	2 4		fx (MM)/DCC
11	1	11	1 2 4		fx (MM)/DCC
12	1	12	3 4		fx (MM)/DCC
13	1	13	1 3 4		fx (MM)/DCC
14	1	14	2 3 4		fx (MM)/DCC
15	1	15	1 2 3 4		fx (MM)/DCC
16	1	16	5		fx (MM)/DCC
17	2	1	1 5		fx (MM)/DCC
18	2	2	2 5		fx (MM)/DCC
19	2	3	1 2 5		fx (MM)/DCC
20	2	4	3 5		fx (MM)/DCC
21	2	5	1 3 5		fx (MM)/DCC
22	2	6	2 3 5		fx (MM)/DCC
23	2	7	1 2 3 5		fx (MM)/DCC
24	2	8	4 5		fx (MM)/DCC
25	2	9	1 4 5		fx (MM)/DCC
26	2	10	2 4 5		fx (MM)/DCC



				10 (0/1)	
27	2	11	1 2 4 5		fx (MM)/DCC
28	2	12	3 4 5		fx (MM)/DCC
29	2	13	1 3 4 5		fx (MM)/DCC
30	2	14	2 3 4 5		fx (MM)/DCC
31	2	15	1 2 3 4 5		fx (MM)/DCC
32	2	16	6		fx (MM)/DCC
33	3	1	1 6		fx (MM)/DCC
34	3	2	2 6		fx (MM)/DCC
35	3	3	1 2 6		fx (MM)/DCC
36	3	4	3 6		fx (MM)/DCC
37	3	5	1 3 6		fx (MM)/DCC
38	3	6	2 3 6		fx (MM)/DCC
39	3	7	1 2 3 6		fx (MM)/DCC
40	3	8	4 6		fx (MM)/DCC
41	3	9	1 4 6		fx (MM)/DCC
42	3	10	2 4 6		fx (MM)/DCC
43	3	11	1 2 4 6		fx (MM)/DCC
44	3	12	3 4 6		fx (MM)/DCC
45	3	13	1 3 4 6		fx (MM)/DCC
46	3	14	2 3 4 6		fx (MM)/DCC
47	3	15	1 2 3 4 6		fx (MM)/DCC
48	3	16	5 6		fx (MM)/DCC
49	4	1	1 5 6		fx (MM)/DCC
50	4	2	2 5 6		fx (MM)/DCC
51	4	3	1 2 5 6		fx (MM)/DCC









				10 (0/1)					
52	4	4		3	5	6	fx (MM)/DCC		
53	4	5	1	3	5	6	fx (MM)/DCC		
54	4	6	2	3	5	6	fx (MM)/DCC		
55	4	7	1	2	3	5	6	fx (MM)/DCC	
56	4	8			4	5	6	fx (MM)/DCC	
57	4	9	1		4	5	6	fx (MM)/DCC	
58	4	10	2		4	5	6	fx (MM)/DCC	
59	4	11	1	2		4	5	6	fx (MM)/DCC
60	4	12		3	4	5	6	fx (MM)/DCC	
61	4	13	1		3	4	5	6	fx (MM)/DCC
62	4	14	2	3	4	5	6	fx (MM)/DCC	
63	4	15	1	2	3	4	5	6	fx (MM)/DCC
64	4	16					7	fx (MM)/DCC	
65	5	1	1				7	fx (MM)/DCC	
66	5	2	2				7	fx (MM)/DCC	
67	5	3	1	2			7	fx (MM)/DCC	
68	5	4		3			7	fx (MM)/DCC	
69	5	5	1	3			7	fx (MM)/DCC	
70	5	6	2	3			7	fx (MM)/DCC	
71	5	7	1	2	3		7	fx (MM)/DCC	
72	5	8			4		7	fx (MM)/DCC	
73	5	9	1		4		7	fx (MM)/DCC	
74	5	10	2		4		7	fx (MM)/DCC	
75	5	11	1	2		4	7	fx (MM)/DCC	
76	5	12		3	4		7	fx (MM)/DCC	



				10 (0/1)					
77	5	13	1	3	4		7	fx (MM)/DCC	
78	5	14	2	3	4		7	fx (MM)/DCC	
79	5	15	1	2	3	4	7	fx (MM)/DCC	
80	5	16			5	7	7	fx (MM)/DCC	
81	6	1	1		5	7	7	fx (MM)/DCC	
82	6	2	2		5	7	7	fx (MM)/DCC	
83	6	3	1	2		5	7	fx (MM)/DCC	
84	6	4		3	5	7	7	fx (MM)/DCC	
85	6	5	1	3	5	7	7	fx (MM)/DCC	
86	6	6	2	3	5	7	7	fx (MM)/DCC	
87	6	7	1	2	3	5	7	fx (MM)/DCC	
88	6	8			4	5	7	fx (MM)/DCC	
89	6	9	1		4	5	7	fx (MM)/DCC	
90	6	10	2		4	5	7	fx (MM)/DCC	
91	6	11	1	2	4	5	7	fx (MM)/DCC	
92	6	12		3	4	5	7	fx (MM)/DCC	
93	6	13	1	3	4	5	7	fx (MM)/DCC	
94	6	14	2	3	4	5	7	fx (MM)/DCC	
95	6	15	1	2	3	4	5	7	fx (MM)/DCC
96	6	16				6	7	fx (MM)/DCC	
97	7	1	1			6	7	fx (MM)/DCC	
98	7	2	2			6	7	fx (MM)/DCC	
99	7	3	1	2		6	7	fx (MM)/DCC	
100	7	4		3		6	7	fx (MM)/DCC	
101	7	5	1	3		6	7	fx (MM)/DCC	



										10 (0/1)
102	7	6	2	3	6	7			fx (MM)/DCC	
103	7	7	1	2	3	6	7		fx (MM)/DCC	
104	7	8			4	6	7		fx (MM)/DCC	
105	7	9	1		4	6	7		fx (MM)/DCC	
106	7	10	2		4	6	7		fx (MM)/DCC	
107	7	11	1	2	4	6	7		fx (MM)/DCC	
108	7	12		3	4	6	7		fx (MM)/DCC	
109	7	13	1		3	4	6	7	fx (MM)/DCC	
110	7	14	2	3	4	6	7		fx (MM)/DCC	
111	7	15	1	2	3	4	6	7	fx (MM)/DCC	
112	7	16			5	6	7		fx (MM)/DCC	
113	8	1	1		5	6	7		fx (MM)/DCC	
114	8	2	2		5	6	7		fx (MM)/DCC	
115	8	3	1	2		5	6	7	fx (MM)/DCC	
116	8	4		3	5	6	7		fx (MM)/DCC	
117	8	5	1	3	5	6	7		fx (MM)/DCC	
118	8	6	2	3	5	6	7		fx (MM)/DCC	
119	8	7	1	2	3	5	6	7	fx (MM)/DCC	
120	8	8			4	5	6	7	fx (MM)/DCC	
121	8	9	1		4	5	6	7	fx (MM)/DCC	
122	8	10	2		4	5	6	7	fx (MM)/DCC	
123	8	11	1	2		4	5	6	7	fx (MM)/DCC
124	8	12		3	4	5	6	7	fx (MM)/DCC	
125	8	13	1	3	4	5	6	7	fx (MM)/DCC	
126	8	14	2	3	4	5	6	7	fx (MM)/DCC	
127	8	15	1	2	3	4	5	6	7	fx (MM)/DCC



										10 (0/1)
128	8	16						8	fx (MM)/DCC	
129	9	1	1					8	fx (MM)/DCC	
130	9	2		2				8	fx (MM)/DCC	
131	9	3	1	2				8	fx (MM)/DCC	
132	9	4			3			8	fx (MM)/DCC	
133	9	5	1	3				8	fx (MM)/DCC	
134	9	6		2	3			8	fx (MM)/DCC	
135	9	7	1	2	3			8	fx (MM)/DCC	
136	9	8			4			8	fx (MM)/DCC	
137	9	9	1		4			8	fx (MM)/DCC	
138	9	10	2		4			8	fx (MM)/DCC	
139	9	11	1	2	4			8	fx (MM)/DCC	
140	9	12		3	4			8	fx (MM)/DCC	
141	9	13	1	3	4			8	fx (MM)/DCC	
142	9	14	2	3	4			8	fx (MM)/DCC	
143	9	15	1	2	3	4		8	fx (MM)/DCC	
144	9	16			5			8	fx (MM)/DCC	
145	10	1	1		5			8	fx (MM)/DCC	
146	10	2		2	5			8	fx (MM)/DCC	
147	10	3	1	2		5		8	fx (MM)/DCC	
148	10	4		3	5			8	fx (MM)/DCC	
149	10	5	1	3	5			8	fx (MM)/DCC	
150	10	6	2	3	5			8	fx (MM)/DCC	
151	10	7	1	2	3	5		8	fx (MM)/DCC	
152	10	8			4	5		8	fx (MM)/DCC	
153	10	9	1		4	5		8	fx (MM)/DCC	



							10 (0/1)		
154	10	10	2	4	5	8	fx (MM)/DCC		
155	10	11	1	2	4	5	8	fx (MM)/DCC	
156	10	12		3	4	5	8	fx (MM)/DCC	
157	10	13	1	3	4	5	8	fx (MM)/DCC	
158	10	14	2	3	4	5	8	fx (MM)/DCC	
159	10	15	1	2	3	4	5	8	fx (MM)/DCC
160	10	16				6	8	fx (MM)/DCC	
161	11	1	1			6	8	fx (MM)/DCC	
162	11	2	2			6	8	fx (MM)/DCC	
163	11	3	1	2		6	8	fx (MM)/DCC	
164	11	4		3		6	8	fx (MM)/DCC	
165	11	5	1	3		6	8	fx (MM)/DCC	
166	11	6	2	3		6	8	fx (MM)/DCC	
167	11	7	1	2	3		6	8	fx (MM)/DCC
168	11	8			4	6	8	fx (MM)/DCC	
169	11	9	1		4	6	8	fx (MM)/DCC	
170	11	10	2		4	6	8	fx (MM)/DCC	
171	11	11	1	2	4	6	8	fx (MM)/DCC	
172	11	12		3	4	6	8	fx (MM)/DCC	
173	11	13	1	3	4	6	8	fx (MM)/DCC	
174	11	14	2	3	4	6	8	fx (MM)/DCC	
175	11	15	1	2	3	4	6	8	fx (MM)/DCC
176	11	16			5	6	8	fx (MM)/DCC	
177	12	1	1		5	6	8	fx (MM)/DCC	
178	12	2	2		5	6	8	fx (MM)/DCC	
179	12	3	1	2		5	6	8	fx (MM)/DCC



							10 (0/1)			
180	12	4		3	5	6	8	fx (MM)/DCC		
181	12	5	1	3	5	6	8	fx (MM)/DCC		
182	12	6	2	3	5	6	8	fx (MM)/DCC		
183	12	7	1	2	3	5	6	8	fx (MM)/DCC	
184	12	8			4	5	6	8	fx (MM)/DCC	
185	12	9	1		4	5	6	8	fx (MM)/DCC	
186	12	10	2		4	5	6	8	fx (MM)/DCC	
187	12	11	1	2		4	5	6	8	fx (MM)/DCC
188	12	12		3	4	5	6	8	fx (MM)/DCC	
189	12	13	1	3	4	5	6	8	fx (MM)/DCC	
190	12	14	2	3	4	5	6	8	fx (MM)/DCC	
191	12	15	1	2	3	4	5	6	8	fx (MM)/DCC
192	12	16				7	8	fx (MM)/DCC		
193	13	1	1			7	8	fx (MM)/DCC		
194	13	2	2			7	8	fx (MM)/DCC		
195	13	3	1	2		7	8	fx (MM)/DCC		
196	13	4		3		7	8	fx (MM)/DCC		
197	13	5	1	3		7	8	fx (MM)/DCC		
198	13	6	2	3		7	8	fx (MM)/DCC		
199	13	7	1	2	3		7	8	fx (MM)/DCC	
200	13	8			4	7	8	fx (MM)/DCC		
201	13	9	1		4	7	8	fx (MM)/DCC		
202	13	10	2		4	7	8	fx (MM)/DCC		
203	13	11	1	2	4	7	8	fx (MM)/DCC		
204	13	12		3	4	7	8	fx (MM)/DCC		
205	13	13	1	3	4	7	8	fx (MM)/DCC		



													10 (0/1)
206	13	14		2	3	4			7	8			fx (MM)/DCC
207	13	15	1	2	3	4			7	8			fx (MM)/DCC
208	13	16					5		7	8			fx (MM)/DCC
209	14	1	1				5		7	8			fx (MM)/DCC
210	14	2		2			5		7	8			fx (MM)/DCC
211	14	3	1	2			5		7	8			fx (MM)/DCC
212	14	4			3		5		7	8			fx (MM)/DCC
213	14	5	1		3		5		7	8			fx (MM)/DCC
214	14	6		2	3		5		7	8			fx (MM)/DCC
215	14	7	1	2	3		5		7	8			fx (MM)/DCC
216	14	8				4	5		7	8			fx (MM)/DCC
217	14	9	1			4	5		7	8			fx (MM)/DCC
218	14	10		2		4	5		7	8			fx (MM)/DCC
219	14	11	1	2		4	5		7	8			fx (MM)/DCC
220	14	12			3	4	5		7	8			fx (MM)/DCC
221	14	13	1		3	4	5		7	8			fx (MM)/DCC
222	14	14		2	3	4	5		7	8			fx (MM)/DCC
223	14	15	1	2	3	4	5		7	8			fx (MM)/DCC
224	14	16						6	7	8			fx (MM)/DCC
225	15	1	1					6	7	8			fx (MM)/DCC
226	15	2		2				6	7	8			fx (MM)/DCC
227	15	3	1	2				6	7	8			fx (MM)/DCC
228	15	4			3			6	7	8			fx (MM)/DCC
229	15	5	1		3			6	7	8			fx (MM)/DCC
230	15	6		2	3			6	7	8			fx (MM)/DCC
231	15	7	1	2	3			6	7	8			fx (MM)/DCC



													10 (0/1)
232	15	8					4		6	7	8		fx (MM)/DCC
233	15	9	1				4		6	7	8		fx (MM)/DCC
234	15	10		2			4		6	7	8		fx (MM)/DCC
235	15	11	1	2			4		6	7	8		fx (MM)/DCC
236	15	12			3	4		6	7	8			fx (MM)/DCC
237	15	13	1		3	4		6	7	8			fx (MM)/DCC
238	15	14		2	3	4		6	7	8			fx (MM)/DCC
239	15	15	1	2	3	4		6	7	8			fx (MM)/DCC
240	15	16					5	6	7	8			fx (MM)/DCC
241	16	1	1				5	6	7	8			fx (MM)/DCC
242	16	2		2			5	6	7	8			fx (MM)/DCC
243	16	3	1	2			5	6	7	8			fx (MM)/DCC
244	16	4			3		5	6	7	8			fx (MM)/DCC
245	16	5	1		3		5	6	7	8			fx (MM)/DCC
246	16	6		2	3		5	6	7	8			fx (MM)/DCC
247	16	7	1	2	3		5	6	7	8			fx (MM)/DCC
248	16	8				4	5	6	7	8			fx (MM)/DCC
249	16	9	1			4	5	6	7	8			fx (MM)/DCC
250	16	10		2		4	5	6	7	8			fx (MM)/DCC
251	16	11	1	2		4	5	6	7	8			fx (MM)/DCC
252	16	12			3	4	5	6	7	8			fx (MM)/DCC
253	16	13	1		3	4	5	6	7	8			fx (MM)/DCC
254	16	14		2	3	4	5	6	7	8			fx (MM)/DCC
255	16	15	1	2	3	4	5	6	7	8			fx (MM)/DCC
256	16	16									9		fx (MM)/DCC
257	17	1	1								9		fx (MM)/DCC



				10 (0/1)
258	17	2	2	9 fx (MM)/DCC
259	17	3	1 2	9 fx (MM)/DCC
260	17	4	3	9 fx (MM)/DCC
261	17	5	1 3	9 fx (MM)/DCC
262	17	6	2 3	9 fx (MM)/DCC
263	17	7	1 2 3	9 fx (MM)/DCC
264	17	8	4	9 fx (MM)/DCC
265	17	9	1 4	9 fx (MM)/DCC
266	17	10	2 4	9 fx (MM)/DCC
267	17	11	1 2 4	9 fx (MM)/DCC
268	17	12	3 4	9 fx (MM)/DCC
269	17	13	1 3 4	9 fx (MM)/DCC
270	17	14	2 3 4	9 fx (MM)/DCC
271	17	15	1 2 3 4	9 fx (MM)/DCC
272	17	16	5	9 fx (MM)/DCC
273	18	1	1 5	9 fx (MM)/DCC
274	18	2	2 5	9 fx (MM)/DCC
275	18	3	1 2 5	9 fx (MM)/DCC
276	18	4	3 5	9 fx (MM)/DCC
277	18	5	1 3 5	9 fx (MM)/DCC
278	18	6	2 3 5	9 fx (MM)/DCC
279	18	7	1 2 3 5	9 fx (MM)/DCC
280	18	8	4 5	9 fx (MM)/DCC
281	18	9	1 4 5	9 fx (MM)/DCC
282	18	10	2 4 5	9 fx (MM)/DCC
283	18	11	1 2 4 5	9 fx (MM)/DCC



				10 (0/1)
284	18	12	3 4 5	9 fx (MM)/DCC
285	18	13	1 3 4 5	9 fx (MM)/DCC
286	18	14	2 3 4 5	9 fx (MM)/DCC
287	18	15	1 2 3 4 5	9 fx (MM)/DCC
288	18	16	6	9 fx (MM)/DCC
289	19	1	1 6	9 fx (MM)/DCC
290	19	2	2 6	9 fx (MM)/DCC
291	19	3	1 2 6	9 fx (MM)/DCC
292	19	4	3 6	9 fx (MM)/DCC
293	19	5	1 3 6	9 fx (MM)/DCC
294	19	6	2 3 6	9 fx (MM)/DCC
295	19	7	1 2 3 6	9 fx (MM)/DCC
296	19	8	4 6	9 fx (MM)/DCC
297	19	9	1 4 6	9 fx (MM)/DCC
298	19	10	2 4 6	9 fx (MM)/DCC
299	19	11	1 2 4 6	9 fx (MM)/DCC
300	19	12	3 4 6	9 fx (MM)/DCC
301	19	13	1 3 4 6	9 fx (MM)/DCC
302	19	14	2 3 4 6	9 fx (MM)/DCC
303	19	15	1 2 3 4 6	9 fx (MM)/DCC
304	19	16	5 6	9 fx (MM)/DCC
305	20	1	1 5 6	9 fx (MM)/DCC
306	20	2	2 5 6	9 fx (MM)/DCC
307	20	3	1 2 5 6	9 fx (MM)/DCC
308	20	4	3 5 6	9 fx (MM)/DCC
309	20	5	1 3 5 6	9 fx (MM)/DCC



										10 (0/1)
310	20	6	2	3	5	6	9	fx (MM)/DCC		
311	20	7	1	2	3	5	6	9	fx (MM)/DCC	
312	20	8		4	5	6	9	fx (MM)/DCC		
313	20	9	1		4	5	6	9	fx (MM)/DCC	
314	20	10	2		4	5	6	9	fx (MM)/DCC	
315	20	11	1	2		4	5	6	9	fx (MM)/DCC
316	20	12		3	4	5	6	9	fx (MM)/DCC	
317	20	13	1		3	4	5	6	9	fx (MM)/DCC
318	20	14	2	3	4	5	6	9	fx (MM)/DCC	
319	20	15	1	2	3	4	5	6	9	fx (MM)/DCC
320	20	16					7	9	fx (MM)/DCC	
321	21	1	1				7	9	--- / DCC	
322	21	2		2			7	9	--- / DCC	
323	21	3	1	2			7	9	--- / DCC	
324	21	4			3		7	9	--- / DCC	
325	21	5	1		3		7	9	--- / DCC	
326	21	6		2	3		7	9	--- / DCC	
327	21	7	1	2	3		7	9	--- / DCC	
328	21	8			4		7	9	--- / DCC	
329	21	9	1		4		7	9	--- / DCC	
330	21	10		2	4		7	9	--- / DCC	
331	21	11	1	2		4	7	9	--- / DCC	
332	21	12			3	4	7	9	--- / DCC	
333	21	13	1		3	4	7	9	--- / DCC	
334	21	14		2	3	4	7	9	--- / DCC	
335	21	15	1	2	3	4	7	9	--- / DCC	

										10 (0/1)
336	21	16					5	7	9	--- / DCC
337	22	1	1				5	7	9	--- / DCC
338	22	2		2			5	7	9	--- / DCC
339	22	3	1	2			5	7	9	--- / DCC
340	22	4			3		5	7	9	--- / DCC
341	22	5	1		3		5	7	9	--- / DCC
342	22	6		2	3		5	7	9	--- / DCC
343	22	7	1	2	3		5	7	9	--- / DCC
344	22	8			4	5	7	9	--- / DCC	
345	22	9	1		4	5	7	9	--- / DCC	
346	22	10		2	4	5	7	9	--- / DCC	
347	22	11	1	2		4	5	7	9	--- / DCC
348	22	12			3	4	5	7	9	--- / DCC
349	22	13	1		3	4	5	7	9	--- / DCC
350	22	14		2	3	4	5	7	9	--- / DCC
351	22	15	1	2	3	4	5	7	9	--- / DCC
352	22	16					6	7	9	--- / DCC
353	23	1	1				6	7	9	--- / DCC
354	23	2		2			6	7	9	--- / DCC
355	23	3	1	2			6	7	9	--- / DCC
356	23	4			3		6	7	9	--- / DCC
357	23	5	1		3		6	7	9	--- / DCC
358	23	6		2	3		6	7	9	--- / DCC
359	23	7	1	2	3		6	7	9	--- / DCC
360	23	8			4		6	7	9	--- / DCC
361	23	9	1		4		6	7	9	--- / DCC



										10 (0/1)		
362	23	10	2	4	6	7	9	---	DCC			
363	23	11	1	2	4	6	7	9	---	DCC		
364	23	12		3	4	6	7	9	---	DCC		
365	23	13	1	3	4	6	7	9	---	DCC		
366	23	14		2	3	4	6	7	9	---	DCC	
367	23	15	1	2	3	4	6	7	9	---	DCC	
368	23	16			5	6	7	9	---	DCC		
369	24	1	1		5	6	7	9	---	DCC		
370	24	2		2	5	6	7	9	---	DCC		
371	24	3	1	2		5	6	7	9	---	DCC	
372	24	4		3	5	6	7	9	---	DCC		
373	24	5	1	3	5	6	7	9	---	DCC		
374	24	6		2	3	5	6	7	9	---	DCC	
375	24	7	1	2	3	5	6	7	9	---	DCC	
376	24	8			4	5	6	7	9	---	DCC	
377	24	9	1		4	5	6	7	9	---	DCC	
378	24	10		2	4	5	6	7	9	---	DCC	
379	24	11	1	2	4	5	6	7	9	---	DCC	
380	24	12		3	4	5	6	7	9	---	DCC	
381	24	13	1	3	4	5	6	7	9	---	DCC	
382	24	14		2	3	4	5	6	7	9	---	DCC
383	24	15	1	2	3	4	5	6	7	9	---	DCC
384	24	16						8	9	---	DCC	
385	25	1	1					8	9	---	DCC	
386	25	2		2				8	9	---	DCC	
387	25	3	1	2				8	9	---	DCC	



										10 (0/1)	
388	25	4		3				8	9	---	DCC
389	25	5	1	3				8	9	---	DCC
390	25	6		2	3			8	9	---	DCC
391	25	7	1	2	3			8	9	---	DCC
392	25	8				4		8	9	---	DCC
393	25	9	1			4		8	9	---	DCC
394	25	10		2	4			8	9	---	DCC
395	25	11	1	2	4			8	9	---	DCC
396	25	12		3	4			8	9	---	DCC
397	25	13	1	3	4			8	9	---	DCC
398	25	14		2	3	4		8	9	---	DCC
399	25	15	1	2	3	4		8	9	---	DCC
400	25	16				5		8	9	---	DCC
401	26	1	1			5		8	9	---	DCC
402	26	2		2		5		8	9	---	DCC
403	26	3	1	2		5		8	9	---	DCC
404	26	4		3		5		8	9	---	DCC
405	26	5	1	3		5		8	9	---	DCC
406	26	6		2	3	5		8	9	---	DCC
407	26	7	1	2	3	5		8	9	---	DCC
408	26	8				4	5	8	9	---	DCC
409	26	9	1			4	5	8	9	---	DCC
410	26	10		2		4	5	8	9	---	DCC
411	26	11	1	2		4	5	8	9	---	DCC
412	26	12		3	4	5		8	9	---	DCC
413	26	13	1	3	4	5		8	9	---	DCC

													10 (0/1)
414	26	14		2	3	4	5			8	9	---	DCC
415	26	15	1	2	3	4	5			8	9	---	DCC
416	26	16					6			8	9	---	DCC
417	27	1	1				6			8	9	---	DCC
418	27	2		2			6			8	9	---	DCC
419	27	3	1	2			6			8	9	---	DCC
420	27	4			3		6			8	9	---	DCC
421	27	5	1		3		6			8	9	---	DCC
422	27	6		2	3		6			8	9	---	DCC
423	27	7	1	2	3		6			8	9	---	DCC
424	27	8			4		6			8	9	---	DCC
425	27	9	1		4		6			8	9	---	DCC
426	27	10		2	4		6			8	9	---	DCC
427	27	11	1	2		4		6		8	9	---	DCC
428	27	12			3	4		6		8	9	---	DCC
429	27	13	1		3	4		6		8	9	---	DCC
430	27	14		2	3	4		6		8	9	---	DCC
431	27	15	1	2	3	4		6		8	9	---	DCC
432	27	16				5	6			8	9	---	DCC
433	28	1	1			5	6			8	9	---	DCC
434	28	2		2		5	6			8	9	---	DCC
435	28	3	1	2		5	6			8	9	---	DCC
436	28	4			3	5	6			8	9	---	DCC
437	28	5	1		3	5	6			8	9	---	DCC
438	28	6		2	3	5	6			8	9	---	DCC
439	28	7	1	2	3	5	6			8	9	---	DCC

													10 (0/1)
440	28	8				4	5	6		8	9	---	DCC
441	28	9	1			4	5	6		8	9	---	DCC
442	28	10		2		4	5	6		8	9	---	DCC
443	28	11	1	2		4	5	6		8	9	---	DCC
444	28	12			3	4	5	6		8	9	---	DCC
445	28	13	1		3	4	5	6		8	9	---	DCC
446	28	14		2	3	4	5	6		8	9	---	DCC
447	28	15	1	2	3	4	5	6		8	9	---	DCC
448	28	16						7	8	9	---	DCC	
449	29	1	1					7	8	9	---	DCC	
450	29	2		2				7	8	9	---	DCC	
451	29	3	1	2				7	8	9	---	DCC	
452	29	4			3			7	8	9	---	DCC	
453	29	5	1		3			7	8	9	---	DCC	
454	29	6		2	3			7	8	9	---	DCC	
455	29	7	1	2	3			7	8	9	---	DCC	
456	29	8				4		7	8	9	---	DCC	
457	29	9	1			4		7	8	9	---	DCC	
458	29	10		2		4		7	8	9	---	DCC	
459	29	11	1	2		4		7	8	9	---	DCC	
460	29	12			3	4		7	8	9	---	DCC	
461	29	13	1		3	4		7	8	9	---	DCC	
462	29	14		2	3	4		7	8	9	---	DCC	
463	29	15	1	2	3	4		7	8	9	---	DCC	
464	29	16					5	7	8	9	---	DCC	
465	30	1	1				5	7	8	9	---	DCC	



				10 (0/1)							
466	30	2		2		5	7	8	9	---/DCC	
467	30	3	1	2		5	7	8	9	---/DCC	
468	30	4		3	5	7	8	9		---/DCC	
469	30	5	1	3	5	7	8	9		---/DCC	
470	30	6		2	3	5	7	8	9	---/DCC	
471	30	7	1	2	3	5	7	8	9	---/DCC	
472	30	8			4	5	7	8	9	---/DCC	
473	30	9	1		4	5	7	8	9	---/DCC	
474	30	10		2	4	5	7	8	9	---/DCC	
475	30	11	1	2		4	5	7	8	9	---/DCC
476	30	12		3	4	5	7	8	9	---/DCC	
477	30	13	1	3	4	5	7	8	9	---/DCC	
478	30	14		2	3	4	5	7	8	9	---/DCC
479	30	15	1	2	3	4	5	7	8	9	---/DCC
480	30	16				6	7	8	9	---/DCC	
481	31	1	1			6	7	8	9	---/DCC	
482	31	2		2		6	7	8	9	---/DCC	
483	31	3	1	2		6	7	8	9	---/DCC	
484	31	4		3		6	7	8	9	---/DCC	
485	31	5	1	3		6	7	8	9	---/DCC	
486	31	6		2	3	6	7	8	9	---/DCC	
487	31	7	1	2	3	6	7	8	9	---/DCC	
488	31	8			4	6	7	8	9	---/DCC	
489	31	9	1		4	6	7	8	9	---/DCC	
490	31	10		2	4	6	7	8	9	---/DCC	
491	31	11	1	2	4	6	7	8	9	---/DCC	

				10 (0/1)								
492	31	12		3	4	6	7	8	9	---/DCC		
493	31	13	1	3	4	6	7	8	9	---/DCC		
494	31	14		2	3	4	6	7	8	9	---/DCC	
495	31	15	1	2	3	4	6	7	8	9	---/DCC	
496	31	16				5	6	7	8	9	---/DCC	
497	32	1	1			5	6	7	8	9	---/DCC	
498	32	2		2		5	6	7	8	9	---/DCC	
499	32	3	1	2		5	6	7	8	9	---/DCC	
500	32	4		3		5	6	7	8	9	---/DCC	
501	32	5	1	3		5	6	7	8	9	---/DCC	
502	32	6		2	3	5	6	7	8	9	---/DCC	
503	32	7	1	2	3	5	6	7	8	9	---/DCC	
504	32	8			4	5	6	7	8	9	---/DCC	
505	32	9	1		4	5	6	7	8	9	---/DCC	
506	32	10		2	4	5	6	7	8	9	---/DCC	
507	32	11	1	2		4	5	6	7	8	9	---/DCC
508	32	12		3	4	5	6	7	8	9	---/DCC	
509	32	13	1	3	4	5	6	7	8	9	---/DCC	
510	32	14		2	3	4	5	6	7	8	9	---/DCC
511	32	15	1	2	3	4	5	6	7	8	9	---/DCC

Adressen größer 511 können nur im DCC Format ausgegeben werden und müssen mit der CV Programmierung über das Programmiergleis durchgeführt werden.

Addresses larger than 511 can only be assigned in the DCC format and must be done by programming a CV using the programming track.

Les adresses supérieures à 511 peuvent uniquement être éditées dans le format DCC et doivent être exécutées avec la programmation des CV via la voie de programmation.

Adressen groter dan 511 kunnen alleen in het DCC formaat gebruikt worden en moeten met de CV programmering via het programmeerspoor ingesteld worden.

Las direcciones superiores a 511 pueden mostrarse en el formato DCC y deben configurarse con la función Programación de CVs mediante la vía de programación.

Indirizzi maggiori di 511 possono essere assegnati solo nel formato DCC e si devono eseguire con la programmazione delle CV tramite il binario di programmazione.



Due to different legal requirements regarding electro-magnetic compatibility, this item may be used in the USA only after separate certification for FCC compliance and an adjustment if necessary. Use in the USA without this certification is not permitted and absolves us of any liability. If you should want such certification to be done, please contact us – also due to the additional costs incurred for this.

Gebr. Märklin & Cie. GmbH  
Stuttgarter Straße 55 - 57  
73033 Göppingen  
Germany  
[www.maerklin.com](http://www.maerklin.com)



[www.maerklin.com/en/imprint.html](http://www.maerklin.com/en/imprint.html)

197434/0317/Sc3Ef  
Änderungen vorbehalten  
© Gebr. Märklin & Cie. GmbH